



**Politecnico  
di Torino**

**Master's Degree in  
Building Engineering**

Master's Degree Thesis

**Regenerative Design of Politecnico's  
Digital Revolution House**

**Supervisor**

Prof. Marika Mangosio

**Candidate**

Saadoun Alhellani

A.A.22/23

## Contents

Abstract.....	4
1. Introduction .....	5
2. Background and History.....	5
2.1. Context and Purpose.....	5
2.2. Project Evolution.....	5
2.3. Integration into the University.....	6
2.4. Spatial Transformation and Design Principles .....	6
3. A new proposal : .....	6
4. Metadesign Phase.....	6
4.1. Location and Geographical Coordinates.....	6
Surrounding Buildings .....	7
Accessibility and Connections .....	8
4.2. Climate Data.....	8
Mean Monthly Values: standard climatic data - UNI 10349-1 .....	8
Solar irradiation: .....	9
Wind speed: .....	10
Partial vapour pressure:.....	11
5. Space Planning and functionality.....	13
5.1. General considerations from the PRG .....	13
5.2. Needs of the Project : .....	15
Cutting-Edge Laboratories: .....	15
Dynamic Study Rooms: .....	15
Showrooms and Demonstration Areas:.....	16
Lecture Halls and Master Classrooms:.....	16
Co-Working Zones:.....	16
Innovative Workspaces:.....	16
Conference and Event Facilities:.....	17
Administration Offices and Secretariats: .....	17
Research Libraries and Resource Centers:.....	17
Collaboration Areas: .....	17
Parking and Storage Facilities: .....	17
Exploded Diagram : .....	19
5.3. Space Division .....	20
6. Technical Drawings .....	26
Connections and Technical details :.....	42

7. Sustainable Materials and Construction.....	48
Vertical Partitions.....	49
Eco-Friendly Construction.....	49
Sustainable Manufacturing.....	49
Energy Efficiency.....	50
Quick and Efficient Construction.....	50
Precast Prestressed Concrete for Columns and Slabs.....	51
Strength and Durability.....	51
Horizontal Aluminum Sun Louvers.....	52
Aluminum Screen Walls for Facade:.....	52
Curtain Walls:.....	52
Windows/doors:.....	53
Conclusion :.....	54

## Abstract

The "Digital Revolution House" (DRH) is a vital part of the master development strategy at Politecnico di Torino. It's a unique building designed with a focus on sustainability and innovation. It will bring together different fields of study to work on shared projects with external companies. Researchers, businesses, and students collaborate here to turn their research into useful technology for society.

The DRH is strategically located near the headquarters of Politecnico and connects several important areas, creating a cultural and technological hub.

According to the current project, the building itself is designed to fit into a complex area, with different shapes and histories. The DRH has different parts: one side faces inside, one side is dense and compact, one side respects the old building, and the north side opens up to the city and the mountains. Previous plans wanted a courtyard, but it would have closed off the space and hidden the green areas. So, the new design is a long building that works with the shape of the area and lets you see more around it.

This thesis represents a new proposal for the DRH design, which covers all the needs requested. On the ground floor, you'll find spaces for meetings and teaching. The upper floors are for , exhibitions, research, including research labs and a Smart Mobility Center.

This thesis explores the innovative design of the DRH and its dedication to being environmentally friendly. The DRH is an example of how architecture can help create a more sustainable and connected future.

## 1. Introduction

The Digital Revolution House (DRH) embodies the core principles of sustainable architectural engineering. It serves as an example of innovative design, thoughtful material choices, and environmentally-conscious construction techniques, all of which are reshaping the landscape of modern construction. This project stands as a testament to the potential of strategic engineering, harmoniously uniting structural integrity and ecological responsibility.

Before we delve into the details of the DRH, it's important to understand the profound significance of this architectural achievement. At its heart, the DRH is more than a mere physical structure; it represents a new vision. It plays a pivotal role in the university's strategic plan, reflecting a commitment to fostering transdisciplinary experiences and pioneering innovative educational methods. Positioned strategically, the DRH creates a cultural and technological axis that seamlessly integrates with the broader campus, thus facilitating the university's training programs.

The evolution of this project showcases adaptability and forward-thinking. From its initial inclusion in the Impact Platforms system, where the requirements were still taking shape, to the development of design proposals emphasizing sustainability and efficiency, the journey of the DRH is one of continuous refinement.

## 2. Background and History

In response to evolving needs, the Masterplan Team (MPT) undertook a comprehensive redefinition of design themes, resulting in the emergence of the new DRH. This transformation included the integration of various elements, such as spaces dedicated to student collaboration, industry engagement, research activities, showrooms, laboratories, and study areas. Furthermore, it addressed the challenge of bringing activities indoors, which were previously hosted outdoors due to spatial constraints.

The inception of the "Digital Revolution House" (DRH) is deeply rooted in the strategic vision of Politecnico di Torino, where innovation, sustainability, and collaborative research converge to shape the future of academia and technology. In this section, we delve into the historical context and the evolving path that led to the emergence of the DRH.

### 2.1. Context and Purpose

The DRH stands as a cornerstone of Politecnico's strategic plan, designed to enrich the academic landscape and foster transdisciplinary collaboration. Its creation is driven by the university's commitment to nurturing an environment where diverse disciplines converge to work on shared projects in collaboration with external enterprises.

### 2.2. Project Evolution

The evolution of the DRH is a narrative of adaptability and continual definition. Initially, the project was part of the Impact Platforms system, a phase characterized by partially defined requirements and wide-open spaces envisioned for light research laboratories. It was during this period that the Masterplan Team (MPT) embarked on a journey of designing a vision that favored these potential

uses, setting the conceptual course that would ultimately define the DRH's morphology and architectural typology.

### 2.3. Integration into the University

The DRH's strategic location facilitates the creation of a cultural and technological axis, connecting diverse entities that include the ex-OGR area, the historic Politecnico campus, the Mario Boella Institute, Siti, the forthcoming Learning Center, the DRH itself, and the Energy Center. This connection is not just an abstract idea but a tangible reality, brought to life through the revitalization of the axis flanking the OGR complex. The DRH's alignment with the university's strategic goals and training programs ensures its role as an integral part of the academic mission.

### 2.4. Spatial Transformation and Design Principles

The DRH is not only a physical entity but a transformational force that impacts the spatial organization of its surroundings. Its design principles, driven by sustainability, adaptability, and resilience, echo the strategic objectives of the university, making the DRH a vibrant testament to visionary architecture.

## 3. A new proposal :

The Digital Revolution House (DRH) stands as a pivotal structure at Politecnico di Torino, showcasing innovative architectural practices. It serves as a collaborative space where researchers, businesses, and students unite to develop technologies for societal advancement.

DRH symbolizes the convergence of cultural and technological advancements. Positioned strategically within the campus, it signifies the university's commitment to forward-thinking education and sustainability.

The evolution of the DRH project demonstrates its adaptability and evolution over time. Initially conceptualized within the Impact Platforms program, it has transformed into an environmentally conscious design, showcasing the capacity for ideas to evolve and improve.

My thesis introduces a novel proposal for the DRH, maintaining the building's rectangular shape while suggesting modifications in space allocation and usage. The proposed design reimagines the interior spaces, envisioning the ground floor for meetings and educational purposes, and the upper floors for exhibitions, research facilities, laboratories, and a Smart Mobility Center.

Despite the proposed changes, the new design retains the building's original rectangular form, emphasizing a sustainable approach. This approach serves as a testament to how buildings can be reimagined and repurposed without altering their fundamental structure, furthering the journey towards environmentally conscious architectural practices.

## 4. Metadesign Phase

### 4.1. Location and Geographical Coordinates

Via Nino Bixio 14, 10138 Torino TO

**Latitude:** 45° 4' 3.288" N

Longitude: 7° 39' 21.564" E

Altitude: 254 m



Figure 1- Satellite image of the site and neighborhood

### Surrounding Buildings

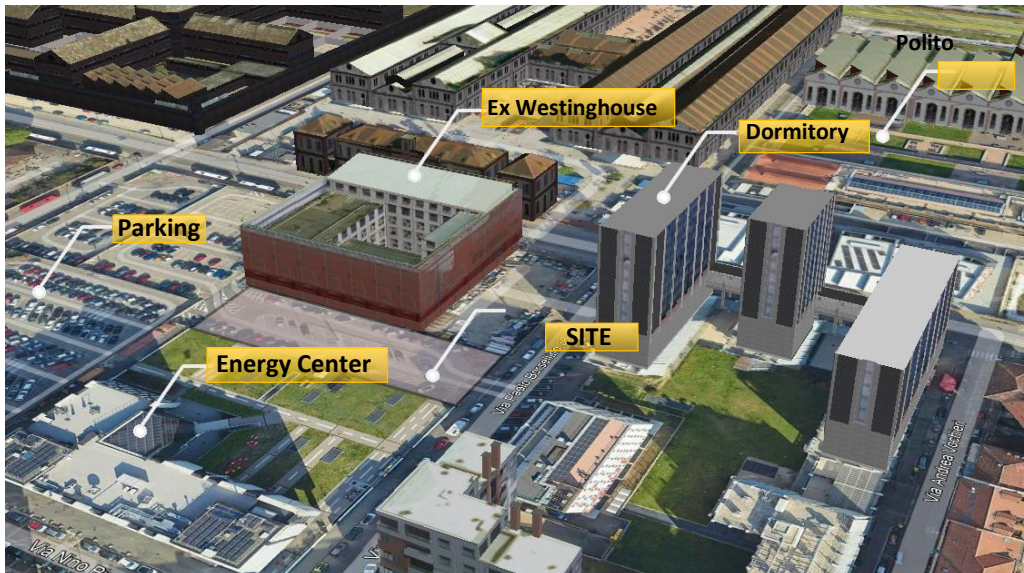

Figure 2- Surrounding Buildings

The location only serves to strengthen the role of the Digital Revolution House (DRH): it is situated in an area dominated by Politecnico di Torino and adjacent to numerous other activities such as the former OGRs, the Mario Boella Institute (a non-profit research and innovation institute), the future Learning Center, the Energy Center, the Siti, the startup incubator I3P, and others. With this proximity, DHR will not only establish a new physical technological axis but, more importantly, an ideological one, given the disciplines and interests that these various activities share.

## Accessibility and Connections



Figure 3- Roads and transportation

### 4.2. Climate Data

To acquire the climatic data needed, it was selected the nearest weather station to the case study, the Torino Bauducchi one. After this identification comes the following data:

$h_{ref} = 226 \text{ m}$

$h = 254 \text{ m}$

where  $h_{ref}$  is the altitude reference station and  $h$  is the altitude of the site's case study.

Mean Monthly Values: standard climatic data - UNI 10349-1

Average monthly values were calculated of:

1 - **The average monthly external temperature** of the reference location and the correction factor were calculated and identified according to the correction formula:

$$t_e = t_{e,ref} - (h - h_{ref}) \cdot d$$

The mean external temperature values of TO Bauducchi used in the following table were taken from Table 5 UNI 10349-1.

Tab. 1 mean external temperature values

	Jan	Feb	Mar	Apr	May	Jun	Jul	Aug	Sep	Oct	Nov	Dec	Annual mean
	[°C]	[°C]	[°C]	[°C]	[°C]	[°C]	[°C]	[°C]	[°C]	[°C]	[°C]	[°C]	[°C]
TO	1.3	3.2	8.4	12	18.1	22.2	23.7	22.7	19.2	12.4	6.9	2.7	12.8
DHR	1.46	3.36	8.56	12.16	18.26	22.36	23.86	22.86	19.36	12.56	7.06	2.86	12.96



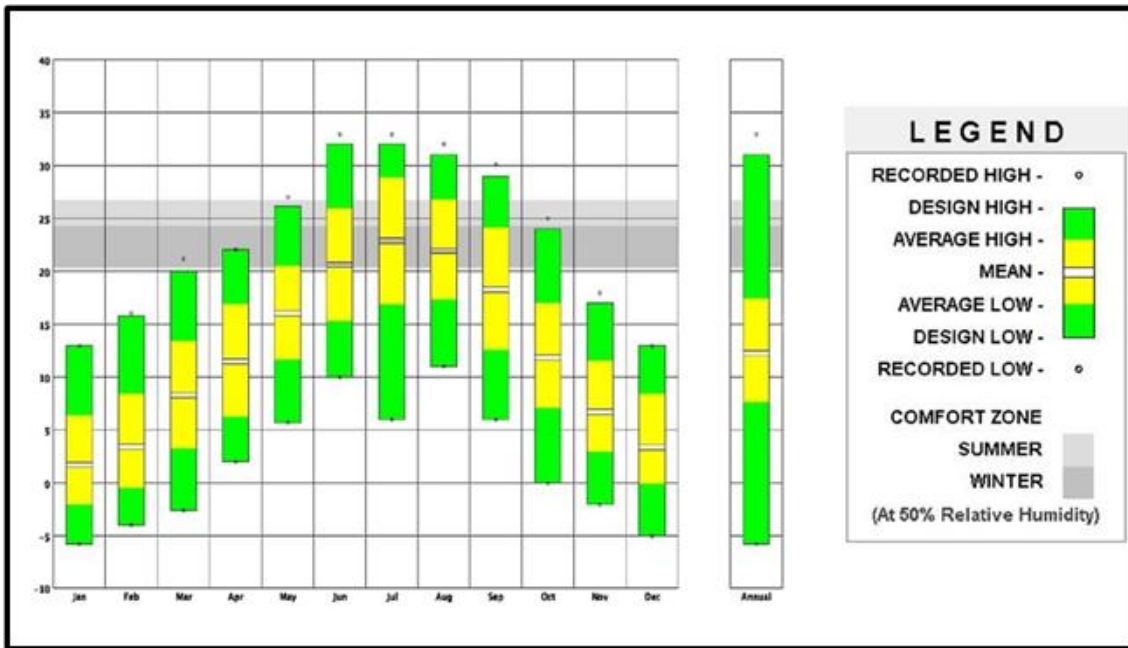

Figure 4-annual temperature profile

Solar irradiation:

According to Table 6 UNI 10349-1 was identified the global solar irradiation on the horizontal plan in the direct and diffuse portions of reference station. As for the temperature data was made a correction, indeed it was calculated the radiation on oriented vertical surface with the application of Appendix C (monthly basis datum).

Solar Irradiation on horizontal surface												
Month	January	February	March	April	May	June	July	August	September	October	November	December
	[MJ/m <sup>2</sup> ]	[MJ/m <sup>2</sup> ]	[MJ/m <sup>2</sup> ]	[MJ/m <sup>2</sup> ]	[MJ/m <sup>2</sup> ]	[MJ/m <sup>2</sup> ]	[MJ/m <sup>2</sup> ]	[MJ/m <sup>2</sup> ]	[MJ/m <sup>2</sup> ]	[MJ/m <sup>2</sup> ]	[MJ/m <sup>2</sup> ]	[MJ/m <sup>2</sup> ]
Direct	2.4	3.8	4.9	6.1	8.3	9.1	8.8	7.6	6	4.3	2.8	2
Diffuse	2.2	3.9	6.8	9.9	11.4	13.7	15.2	12.6	8.6	4.7	2	1.9

Tab. 2 Solar irradiation on horizontal surface

Solar Irradiation on orientated vertical surface (total)												
Month	January	February	March	April	May	June	July	August	September	October	November	December
	[MJ/m <sup>2</sup> ]	[MJ/m <sup>2</sup> ]	[MJ/m <sup>2</sup> ]	[MJ/m <sup>2</sup> ]	[MJ/m <sup>2</sup> ]	[MJ/m <sup>2</sup> ]	[MJ/m <sup>2</sup> ]	[MJ/m <sup>2</sup> ]	[MJ/m <sup>2</sup> ]	[MJ/m <sup>2</sup> ]	[MJ/m <sup>2</sup> ]	[MJ/m <sup>2</sup> ]
North	1,46	2,36	3,45	5,14	8,03	9,82	9,25	7,10	4,63	2,86	1,57	1,33
South	7,25	11,81	12,48	9,82	10,04	10,18	10,46	10,82	10,73	9,87	7,78	9,39
West/East	3,30	6,43	9,30	10,32	12,92	14,43	14,68	12,59	9,65	6,41	3,77	3,72

Tab. 3 Solar irradiation on orientated vertical surface (total)

Therefore, monthly average values of the average daily solar radiation were calculated in the following table.

Torino Bauducchi	Mean monthly values of daily global solar irradiation [MJ/m <sup>2</sup> ], UNI 10349-1											
	Jan	Feb	Mar	Apr	May	Jun	Jul	Aug	Sep	Oct	Nov	Dec
<b>H</b>	4,60	7,70	11,70	16,00	19,70	22,80	24,00	20,20	14,60	9,00	4,80	3,90
<b>N</b>	1,46	2,36	3,45	5,14	8,03	9,82	9,25	7,10	4,63	2,86	1,57	1,33
<b>NE/NW</b>	1,60	3,13	5,42	7,57	10,66	12,44	12,26	9,86	6,68	3,75	1,82	1,46
<b>E/W</b>	3,30	6,43	9,30	10,32	12,92	14,43	14,68	12,59	9,65	6,41	3,77	3,72
<b>SE/SW</b>	5,69	9,81	11,80	10,88	12,08	12,69	13,11	12,49	10,99	8,70	6,21	7,16
<b>S</b>	7,25	11,81	12,48	9,82	10,04	10,18	10,46	10,82	10,73	9,87	7,78	9,39

Tab. 4 Mean monthly values of daily global solar irradiation

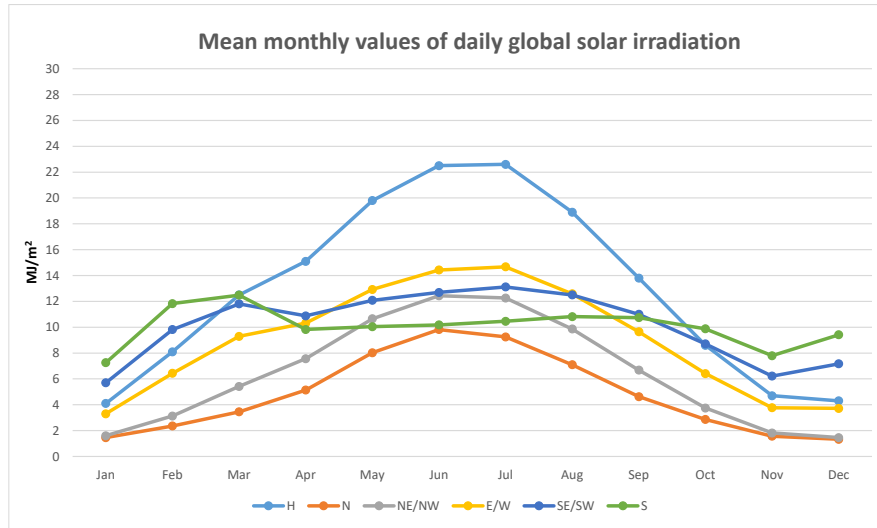

Figure 5-Mean monthly values of daily global solar irradiation-UNI 10349-1 spreadsheet Appendix C. xlsx

Wind speed:

According to the standard Table 2 UNI 10349-1 the wind region is the A, the wind zone is the 1 and the prevalent direction is NE.

Month	Wind Speed											
	January [m/s]	February [m/s]	March [m/s]	April [m/s]	May [m/s]	June [m/s]	July [m/s]	August [m/s]	September [m/s]	October [m/s]	November [m/s]	December [m/s]
TO Baducchi	1.3	1.3	1.6	1.9	1.9	1.6	1.6	1.4	1.1	1.2	1.5	0.9
Case study	1.3	1.3	1.6	1.9	1.9	1.6	1.6	1.4	1.1	1.2	1.5	0.9

Tab. 5 Wind speed



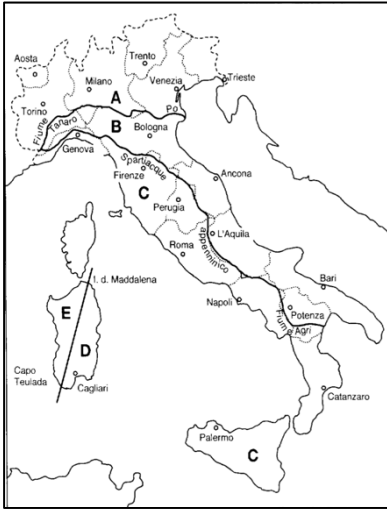

Figure 6- Wind region classification on National territory-UNI10349-1

Wind region	A
Wind zone	1
Identification of the correction coefficient	1

Tab. 6 Wind characteristics case study

Regione di vento	Fascia costiera ≤ 20 km	Fascia Subcostiera ≤ 40 km	Entroterra <sup>1)</sup> > 20 km Altitudine (m)						
			300	500	800	1200	1500	2000	>2000
A	3	2	1	1	2	2	3	3	4
B	2		1	2	2	3	3	4	4
C	3		2	2	3	3	3	4	4
D	3		3	3	3	4	4	4	4
E	4		3	3	3	4	4	4	4
*) Ad eccezione della regione A per cui l'entroterra è > 40 km.									

Tab. 5 Table 2 – UNI 10349-1

Partial vapour pressure:

The relative humidity of the reference climatic station was calculated using values about partial vapour pressure in Table 7 – UNI 10349-1 through the following formula:

$$\varphi_{staz} = \frac{P_{v,staz}}{P_{vs}(t_{staz})}$$

Where  $t_{staz}$  is calculated as:

$$t_{sta} \geq 0^{\circ}C: p_{vs}(t_{staz}) = 610,15 \cdot \exp\left(\frac{17,269 \cdot t_{staz}}{t_{staz} + 237,3}\right)$$

$$t_{sta} < 0^{\circ}C: p_{vs}(t_{staz}) = 610,15 \cdot \exp\left(\frac{21,875 \cdot t_{staz}}{t_{staz} + 265,5}\right)$$

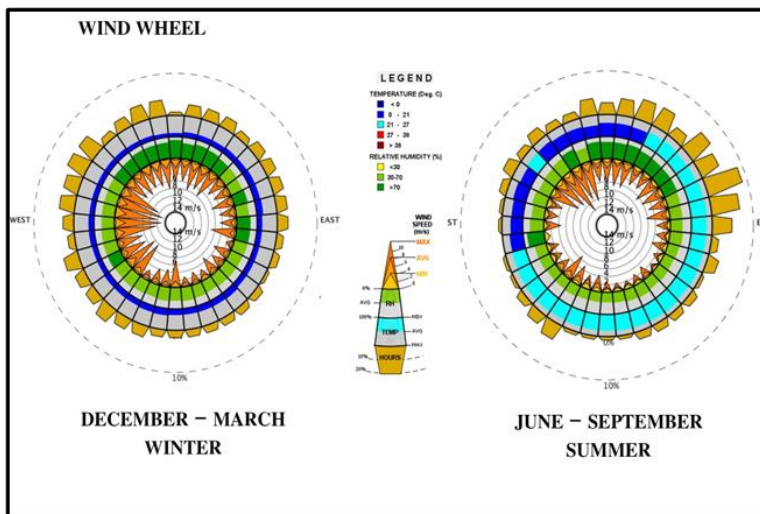

Figure 7-wind wheel

Partial vapour pressure												
Month	January	February	March	April	May	June	July	August	September	October	November	December
	[Pa]	[Pa]	[Pa]	[Pa]	[Pa]	[Pa]	[Pa]	[Pa]	[Pa]	[Pa]	[Pa]	[Pa]
pvs,ref	670,70	768,20	1101,77	1401,81	2075,84	2674,79	2928,90	2757,27	2223,70	1439,21	994,48	741,41
pv,ref	558	618	888	934	1355	1616	1584	2003	1659	1180	925	654
$\phi$ ref	83,20	80,45	80,60	66,63	65,27	60,42	54,08	72,64	74,61	81,99	93,01	88,21
pv,sat	667,21	764,24	1096,32	1395,07	2066,33	2662,93	2916,06	2745,08	2213,61	1432,32	989,50	737,57
pv,case study	555	615	884	930	1349	1609	1577	1994	1651	1174	920	651

Tab. 6 partial vapour pressure

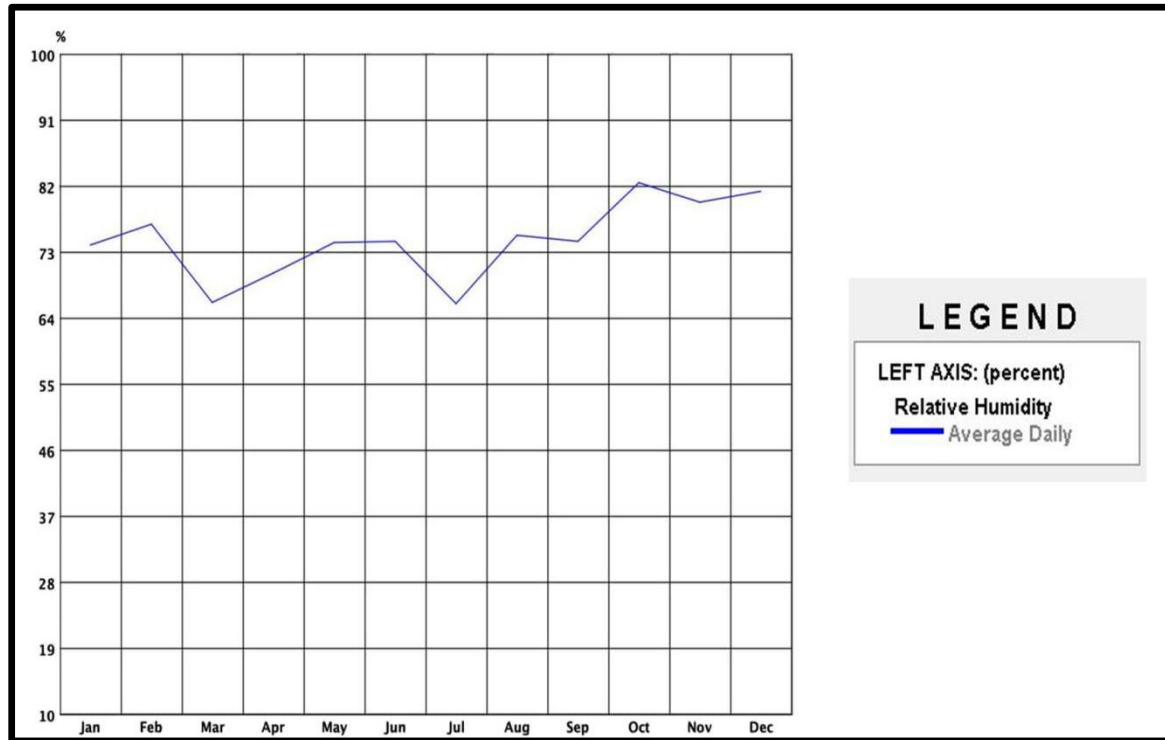

Figure 8-relative humidity profile

## 5. Space Planning and functionality

### 5.1. General considerations from the PRG

Like for all the new building, they must be followed the rules given by the Turin's regulation, in terms of distances from existing building, maximum net floor area and so on. These considerations are resumed in the following tables:

#### At urban scale:

Height	Surface	Position
Maximum reachable height of 35 m	Buildable surface ratio - Construction site' surface ratio $0,8 \text{ m}^2 / \text{m}^2$	No intersection between the boundary of the construction site and the 9/5 omotetic enlargement of the building's confine plan
	Percentage of surface available for people and enterprises' services 35%	
	Percentage of surface available for devices for general interest 65%	

Tab. 7-PRG constraints at urban scale

#### For building with permanent presence of people:

Type	Space	Height	Surface	Position	Aeration/Lighting
Residential	Single lodging	Global minimum 2,7 m; Local minimum 2,0 m	Minimum $28 \text{ m}^2$ (without computing spaces with less then 2 m) width	Possibility to place the level of floor under the level of the external soil (with more than 40% of the partition wall areas under the ground) only if the external partition it is separated from the ground by protection cavity and a ventilated crawl space in the vertical and horizontal direction respectively	Guarantee a DF $\geq 2\%$ or a Raill $\geq 1/8$ , (considering also the contribute derived from a stair lot)
	Double lodging		Minimum $38 \text{ m}^2$ (without computing spaces with less then 2 m) width		
Non-residential	General space		Minimum $9 \text{ m}^2$		

Tab. 8-PRG constraints at building scale (permanent presence of people)

**For building with non-permanent presence of people: (ex. Technical buildings)**

Space	Height	Perimeter	Surface	Position	Technology	Ventilation/Lighting
Mezzanine	Minimum top-down 2,2 m, and down-top 2,0 m	25% of the perimeter must be laterally confined by partitions and the rest by handrail			The height of the handrail must be confined between 1,1-1,2 m	
Restrooms	Minimum 2,4 m	Minimum width 1,5 m and 0,9 m for the primary and secondary respectively	Minimum 3 m <sup>2</sup> and 1,1 m <sup>2</sup> for the primary and the secondary respectively	Possibility to place the level of floor under the level of the external soil (with more than 40% of the partition wall areas under the ground) only if the external partition it is speared from the ground by protection cavity and a ventilated crawl space in the vertical and horizontal direction respectively		Minimum condition set for the primary spaces if supply by natural ventilation (in alternative an idonee mechanical ventilation system with $n \geq 5$ )
Space	Minimum 2,7 m	Minimum width 1,5 m and a depth-width of the acces ratio less the 2/3	Minimum 4 m <sup>2</sup>			Minimum condition set for the primary spaces if supply by natural ventilation (in alternative an idoneal mechanical ventilation system). In addition to the reequipment of a suction hood

*Tab. 9-PRG constraints at building scale (non-permanent presence of people)*

## 5.2. Needs of the Project :

The Digital Revolution House (DRH) is envisioned to meet a spectrum of vital needs, encompassing an array of specialized spaces and facilities tailored to its role as the nexus of the digital revolution. The following elements are integral to satisfying the diverse functions of this innovative edifice:

### Cutting-Edge Laboratories:

DRH necessitates state-of-the-art laboratories dedicated to multiple fields of digital research. These high-tech spaces should be equipped with the latest computing resources, software, and experimental setups to support innovation in areas such as artificial intelligence, data analysis, cybersecurity, and more.

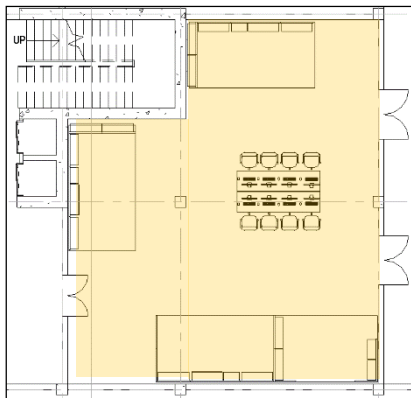

Figure 9- Underground Laboratory

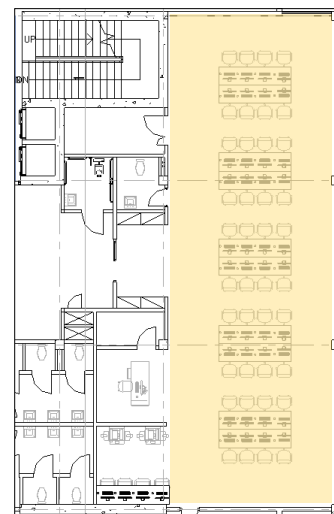

Figure 10- Research Lab

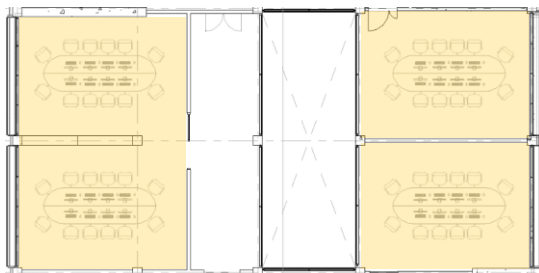

Figure 11- Single Research Labs

### Dynamic Study Rooms:

To encourage collaborative learning and research, a variety of dynamic study rooms should be incorporated. These spaces will be designed to accommodate small groups and individuals, featuring modern technology and resources essential for brainstorming and knowledge exchange.

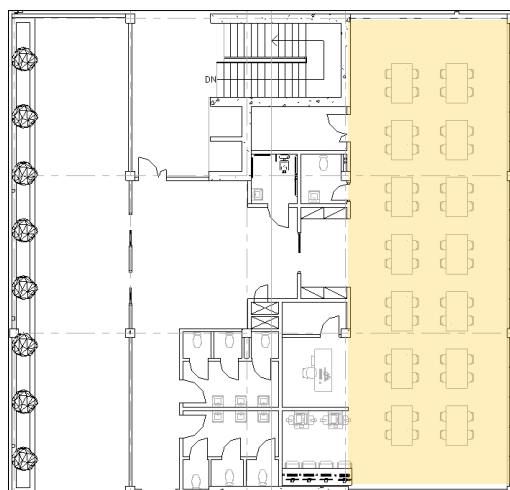

Figure 12- Studyroom

### Showrooms and Demonstration Areas:

As a platform for innovation, DRH must have showrooms and demonstration spaces. These areas will facilitate the display and presentation of cutting-edge digital products and technologies developed through academic-industry partnerships.



Figure 13- Multipurpose areas

### Lecture Halls and Master Classrooms:

The building should house lecture halls and master classrooms, complete with advanced audiovisual equipment to enable effective teaching and learning. These spaces should be adaptable for various teaching formats and equipped with video conferencing capabilities to accommodate remote learning.

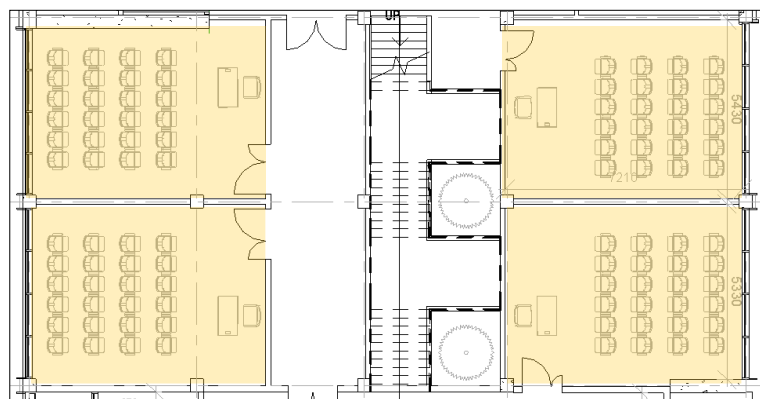

Figure 14- Classrooms

### Co-Working Zones:

To foster collaboration between students, researchers, and industry professionals, co-working areas with comfortable workstations and integrated technology should be available. These zones will encourage interdisciplinary cooperation and networking.

### Innovative Workspaces:

To cater to start-ups and project teams, flexible, innovative workspaces are essential. These spaces should be designed to facilitate creativity and problem-solving, featuring whiteboards, brainstorming areas, and dedicated computer workstations.



#### Conference and Event Facilities:

DRH should be equipped with conference and event facilities capable of hosting seminars, symposiums, and workshops. These spaces should be versatile and supported by cutting-edge audiovisual systems.

#### Administration Offices and Secretariats:

The building requires administrative offices and secretariats to facilitate its smooth operation. These spaces will serve as the administrative hub for managing the various activities within the facility.

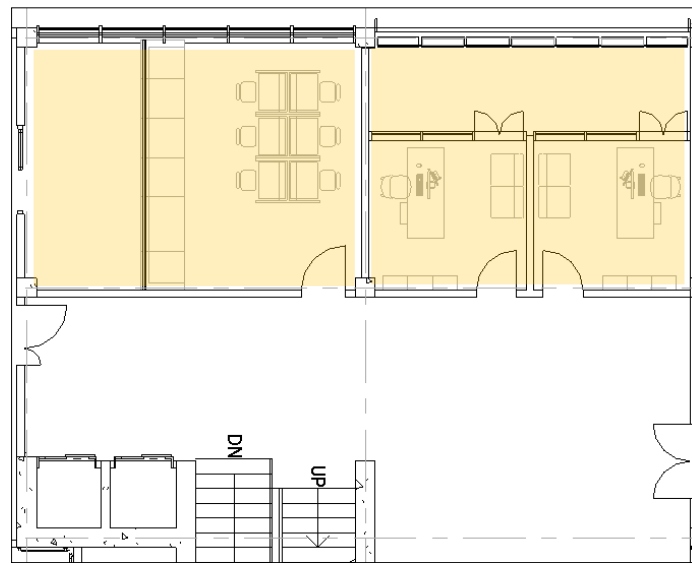

Figure 15- General Secretary and offices

#### Research Libraries and Resource Centers:

Dedicated research libraries and resource centers are crucial to provide access to a vast repository of digital resources, academic journals, and technical literature to support research and learning.

#### Collaboration Areas:

Throughout the building, open collaboration areas should be strategically placed to encourage spontaneous interactions and idea-sharing among students, faculty, and industry partners.

#### Parking and Storage Facilities:

A well-planned basement area is necessary to accommodate parking for staff and visitors, as well as storage for equipment and materials related to research and innovation.

In essence, the Digital Revolution House (DRH) must be a multifaceted space that reflects the dynamic nature of the digital revolution, promoting cross-disciplinary collaboration and innovation.

To fulfill its mission, it must offer a diverse range of meticulously designed spaces and resources tailored to the evolving needs of academia, research, and industry partnerships in the digital age.

Exploded Diagram :

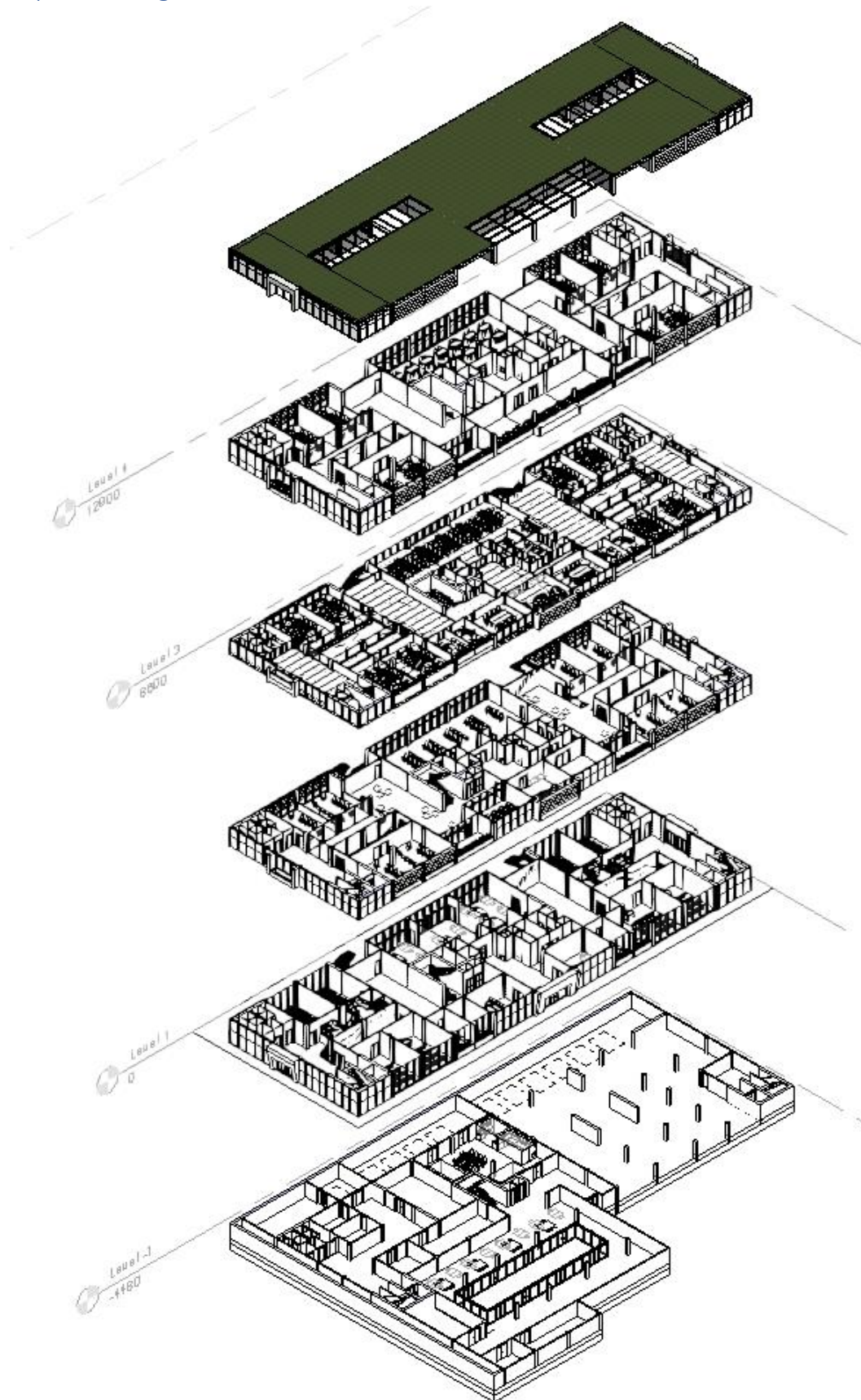

Figure 16- Exploded Diagram

### 5.3. Space Division

#### Basement floor :

The basement of the Digital Revolution House is intelligently divided into three distinct areas, each accessible via separate staircases strategically located throughout the building. The uppermost staircase leads to a section housing deposits, technical rooms, and an isolated room known as "Isola Ecologica," providing a secure and organized space for various utilities and storage. The central staircase guides visitors to the underground team area, directly facing a beautifully landscaped courtyard. This open-air courtyard, accessible from the ground floor, not only floods the space with natural light and fresh air but also offers an inviting atmosphere for those working in this section. On the opposite side of the courtyard, you'll find a cluster of interconnected small offices that encourage collaboration, along with additional storage and technical facilities. The third staircase leads to the parking area, shared with the neighboring building and accessible from the energy center.

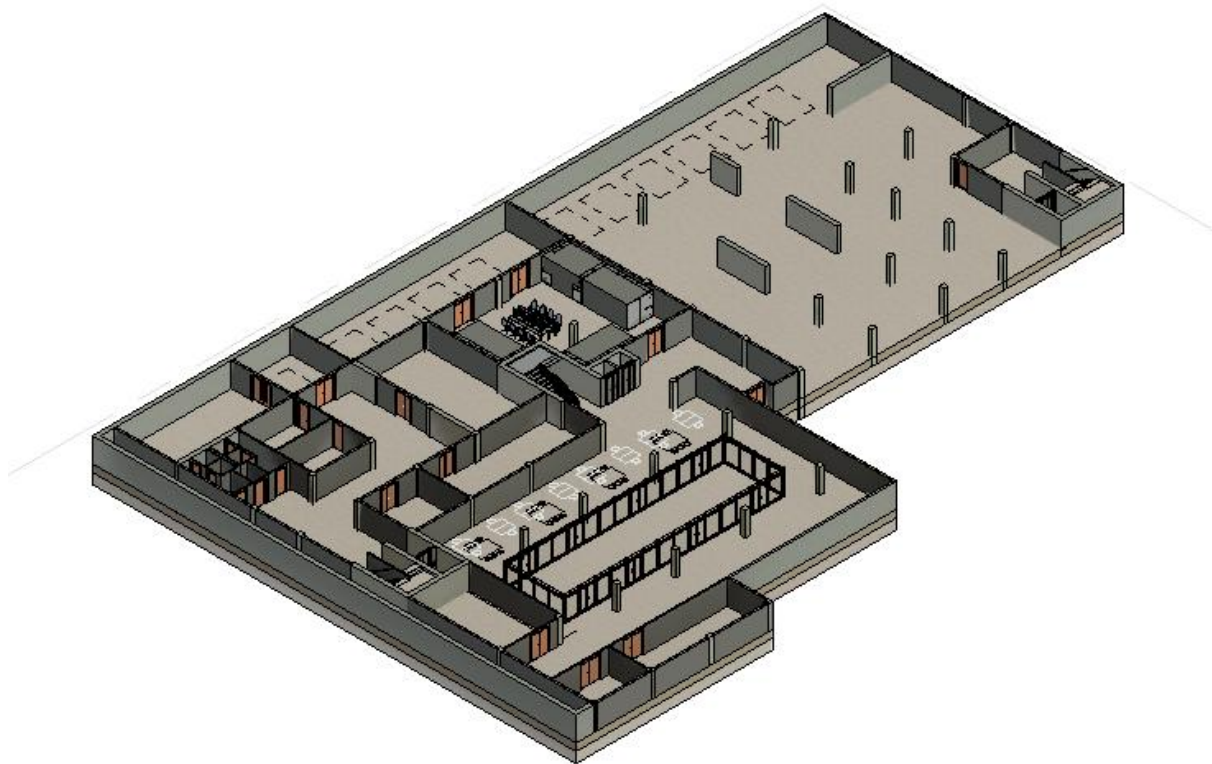

Figure 17- Basement 3D model

### Groundfloor :

The ground floor of the Digital Revolution House offers a well-organized layout, subdivided into three distinct sections. The central part, accessible from the western side through a landscaped area nestled between the energy center and the DRH building, serves as the hub for the building's administration. Here, you'll find the "Segreteria" and collaborative team areas. The upper and lower parts, mirroring each other to the north and south, house a total of eight classrooms, each equipped with essential amenities, including dedicated restroom facilities. What sets this design apart is the inclusion of a central grand staircase in these areas, adorned with furniture and indoor trees, creating a remarkable and refreshing atrium. This dynamic space extends to the roof, allowing ample natural light and ventilation, enhancing the overall atmosphere of the building. The center part is connected to these two sections by a spacious hall designed for functional purposes and enriched with two small offices in each portion. This layout emphasizes efficiency, aesthetics, and an optimal learning environment, promoting synergy and collaboration within the Digital Revolution House.

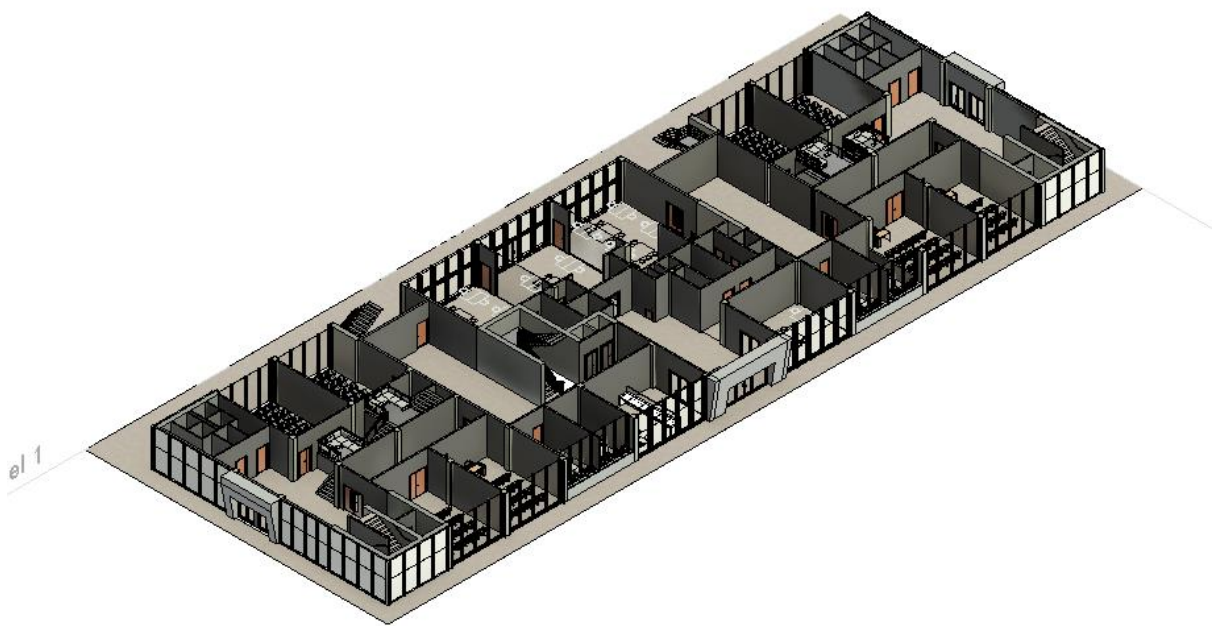

Figure 18- Groundfloor 3d model

### First floor :

The first and second floors of the Digital Revolution House feature a symmetrical layout, with the upper and lower sections mirroring each other. Each of these sections accommodates four state-of-the-art research laboratories, fully equipped with essential services and dedicated staircases. The heart of these floors resides in the central segment, where you'll discover a spacious laboratory suitable for research projects and other versatile uses. Additionally, both the first and second floors offer facilities for hosting conferences, presentations, and innovative showcases, such as an LCD wall and ample seating areas. What makes these floors truly unique is the presence of an elegant atrium connected to the grand staircase, providing a multifunctional space that can be adapted for various purposes. This space serves as a welcoming lounge for students to relax, meet, or engage in casual discussions. It also acts as a showcase area for students to exhibit their innovations. At the end of this hall, a comfortable resting area awaits, making it an ideal location for breaks and mingling. The upper section connects seamlessly to a modern showroom, while the lower section leads directly to the well-equipped conference room. All of these areas are interconnected through the central space of the building, which features vending machines and additional seating areas, enhancing the building's versatility and providing an ideal environment for learning, creativity, and social interaction.

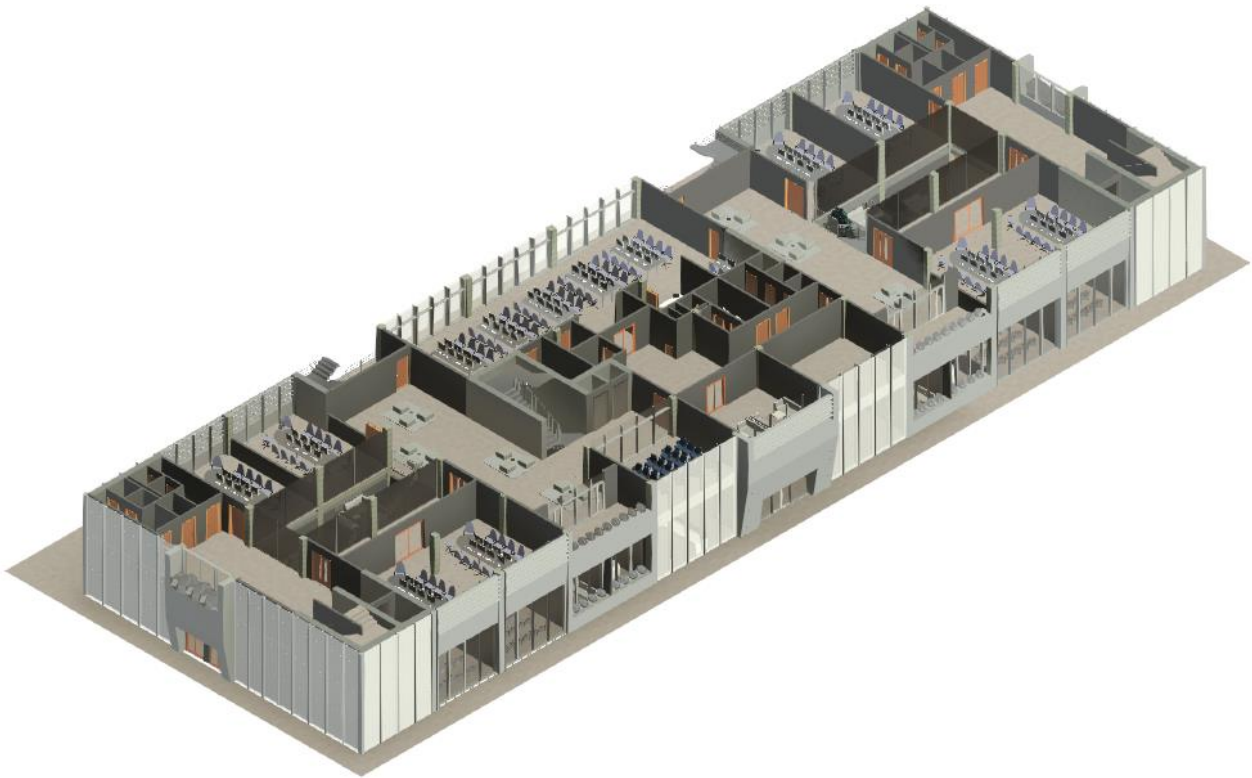

Figure 19- First floor 3D model

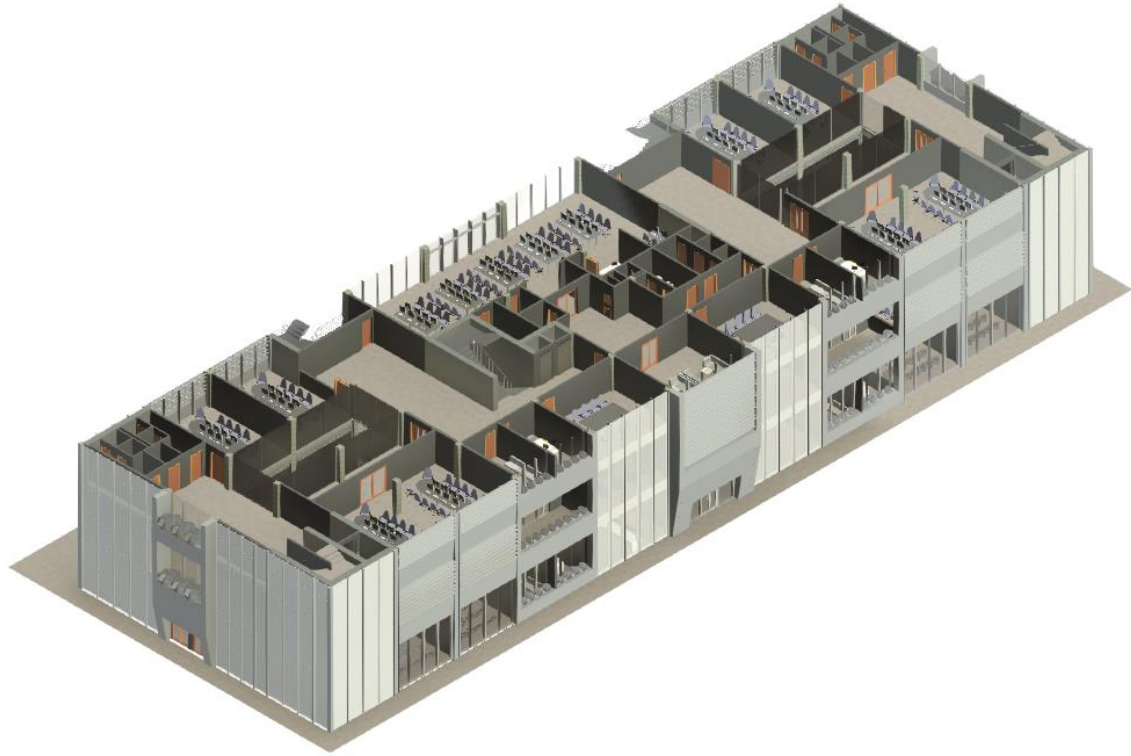

Figure 20- Second floor 3D model

### Third Floor :

The third floor of the Digital Revolution House continues the balanced layout found in previous levels. The upper and lower sections of the building are dedicated to research rooms for students, providing them with conducive environments for focused academic work. At the heart of this floor is a spacious study room, which is overseen by an administrator's office to ensure a conducive learning atmosphere. Additionally, printing services are available to support students' educational needs. A highlight of the third floor is the charming terrace adorned with vibrant vegetation. This outdoor space not only offers a refreshing natural environment but also boasts picturesque views of the landscape situated between the Digital Revolution House and the energy center.

Between the upper section and the central area, you'll find a hall thoughtfully designed for relaxation and exhibition purposes. Similarly, the lower section features a corresponding hall. These spaces serve as comfortable lounges where students can unwind, socialize, and engage in informal discussions. They can also be used for exhibitions and displays, fostering a dynamic and interactive academic atmosphere.

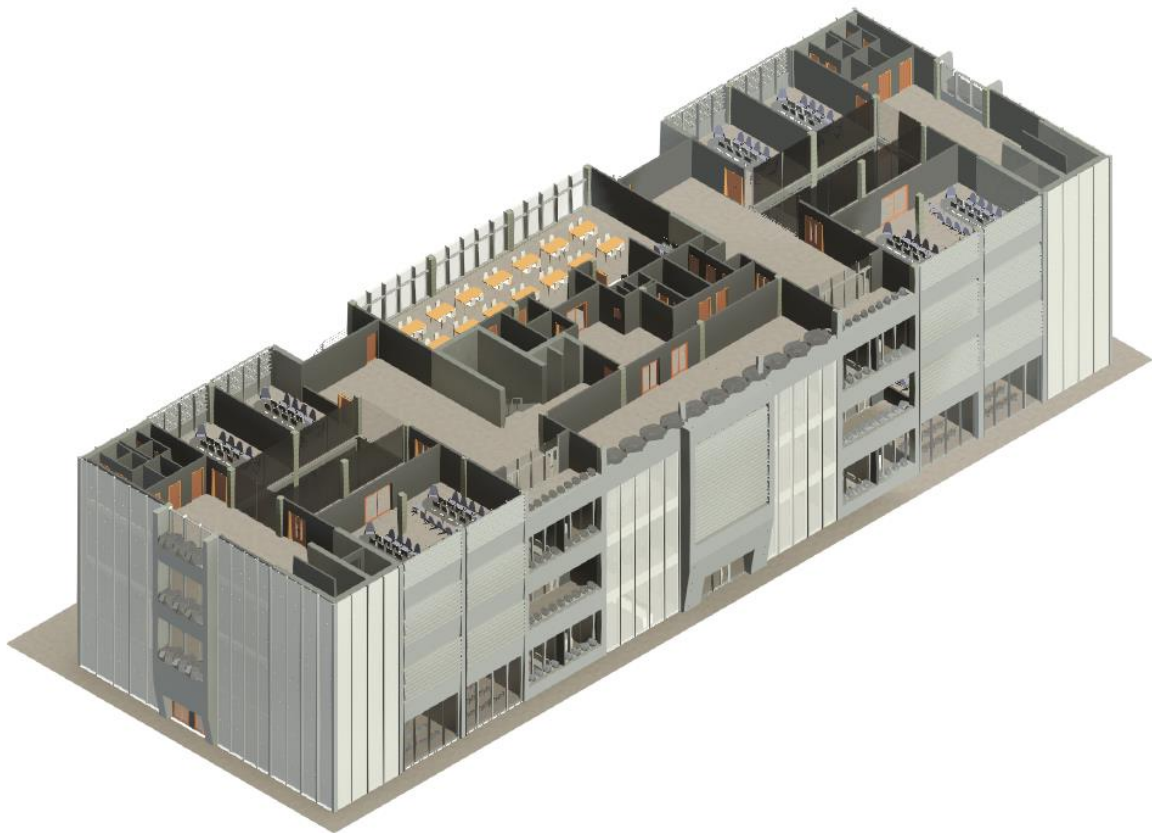

Figure 21- Third Floor 3d model



## Roof :

The roof of the Digital Revolution House (DRH) offers a sustainable and environmentally friendly solution, showcasing a lush green roof design. This innovative feature contributes not only to the building's aesthetic appeal but also to its overall energy efficiency. The roof incorporates two generously-sized skylights that are strategically positioned above the voids located in the central areas of both the upper and lower sections of the building. These voids extend from the ground floor to the first floor and serve as spacious atriums, allowing natural light to filter through, brightening up the interior and creating a visually captivating focal point. It's worth noting that these voids house striking staircases connecting the ground and first floors, enhancing vertical circulation while adding a distinctive architectural element.

The green roof, adorned with a variety of plants and vegetation, offers numerous advantages. It helps regulate indoor temperatures, improving energy efficiency by reducing the building's cooling and heating demands. Additionally, it functions as a natural insulator and absorbs rainwater, mitigating runoff and offering an eco-friendly solution for managing water resources.

Lastly, the roof features an attractive pergola situated above the terrace on the top floor. This delightful outdoor space is ideal for gatherings, relaxation, and events, benefiting from a shaded area while providing a stunning view of the surrounding landscape.

The thoughtful design of the roof underscores the DRH's commitment to sustainability, aesthetics, and providing an inviting environment for students, faculty, and visitors.

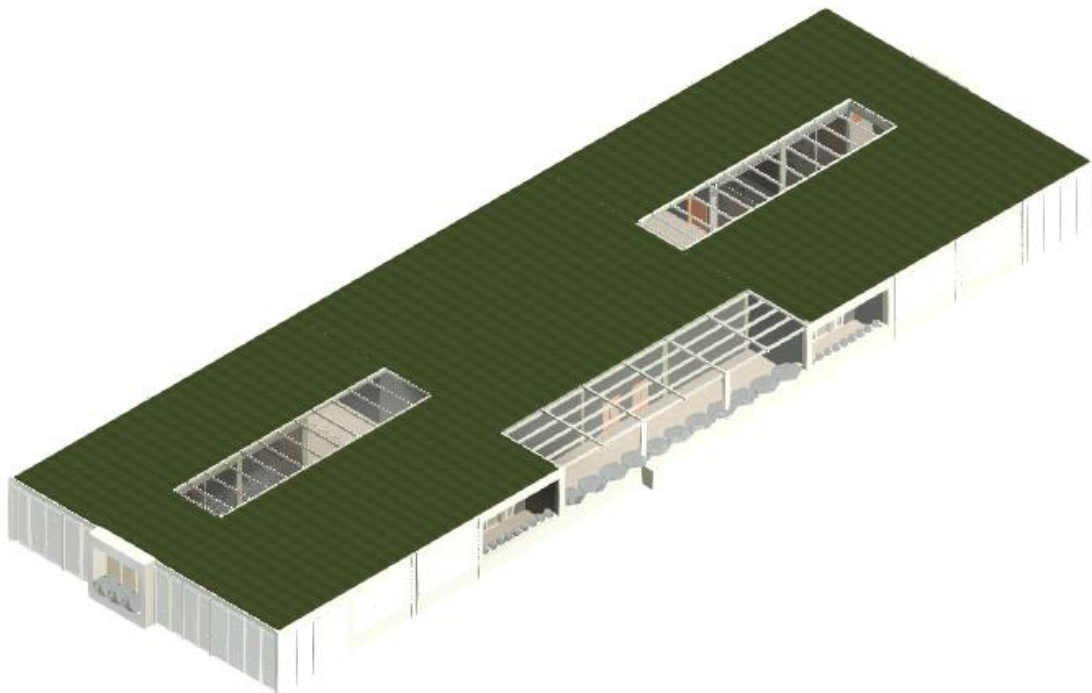

Figure 22- Roof 3d model

## 6. Technical Drawings

VIA NINO BIXIO

VIA PAOLO BORSELLINO

Public Parking

CODEGONE  
RESIDENCE

EX WESTINGHOUSE



**Politecnico  
di Torino**

Master's Degree in Building Engineering  
Candidate: Saadoun Alhellani  
Thesis Supervisor: Prof Marika Mangosio

Regenerative design of  
Politecnico's Revolution House

Site Plan

Scale 1:500

A00



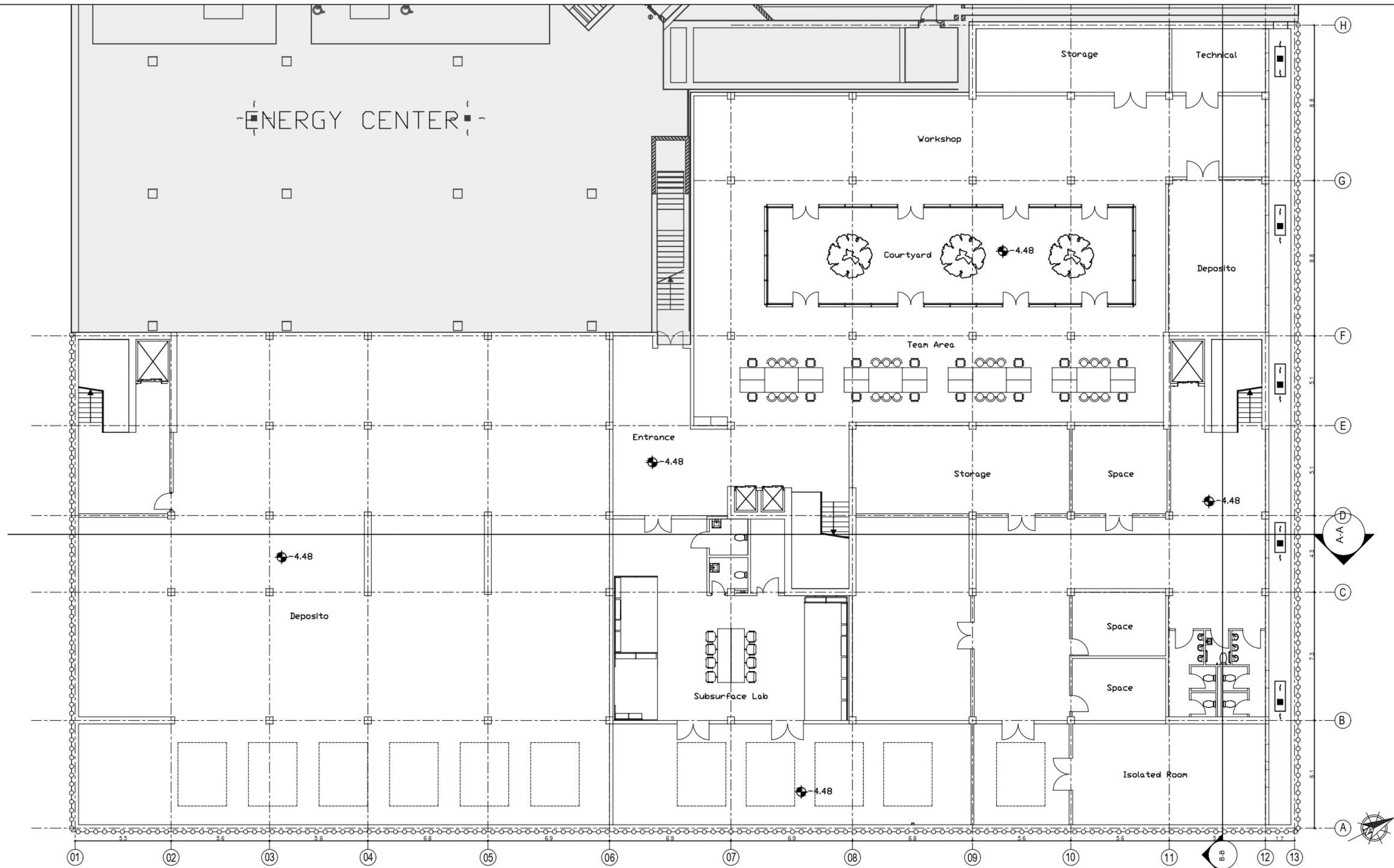

**Politecnico di Torino**

Master's Degree in Building Engineering  
 Candidate: Saadoun Alhellani  
 Thesis Supervisor: Prof Marika Mangosio

Regenerative design of  
 Politecnico's Revolution House

Basement Floor Plan

Scale 1:200

A01

VIA PAOLO BORSELLINO 38

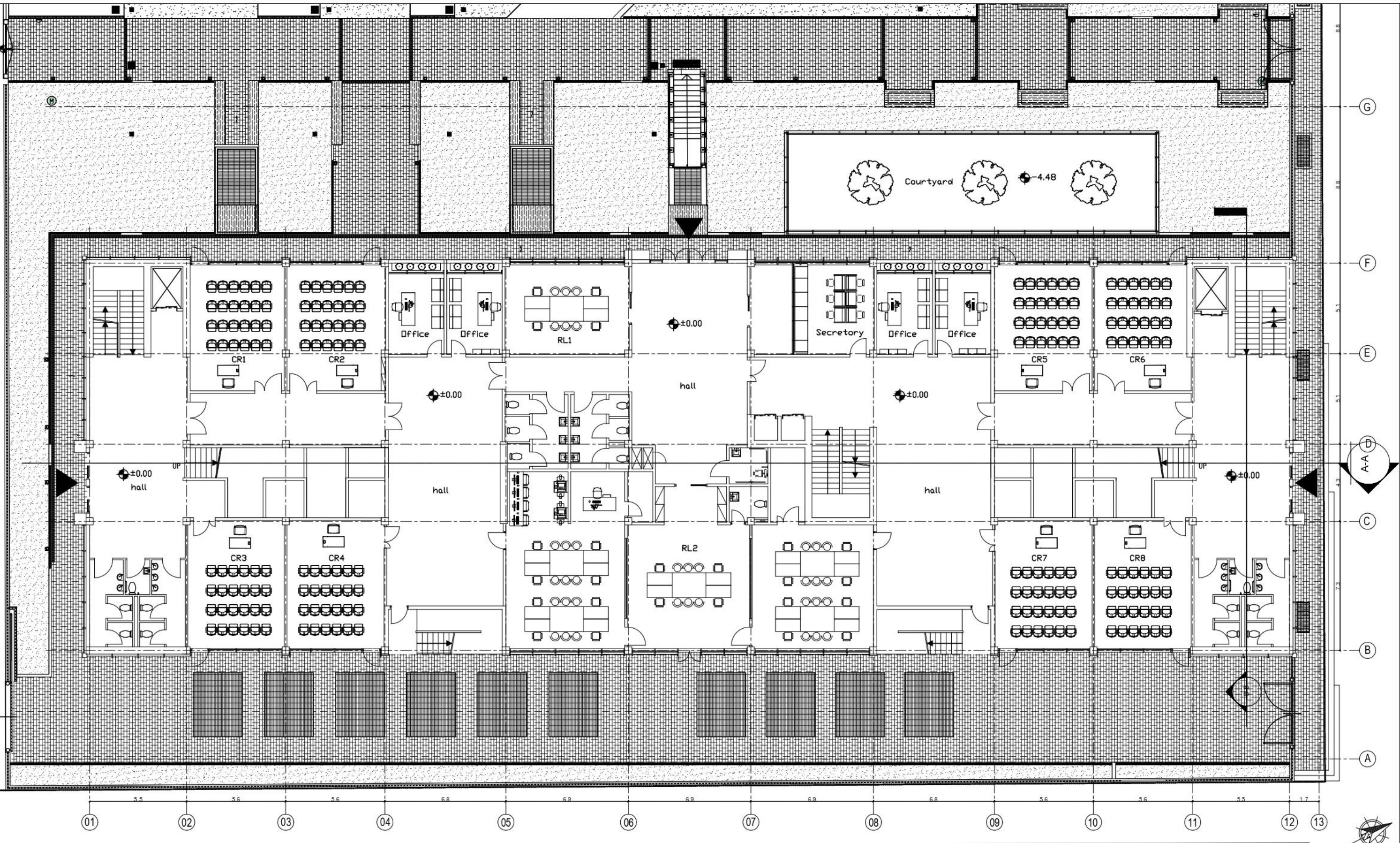

EX WESTINGHOUSE



**Politecnico di Torino**

Master's Degree in Building Engineering  
Candidate: Saadoun Alhellani  
Thesis Supervisor: Prof Marika Mangosio

Regenerative design of  
Politecnico's Revolution House

Ground Floor Plan

Scale 1:200

A02

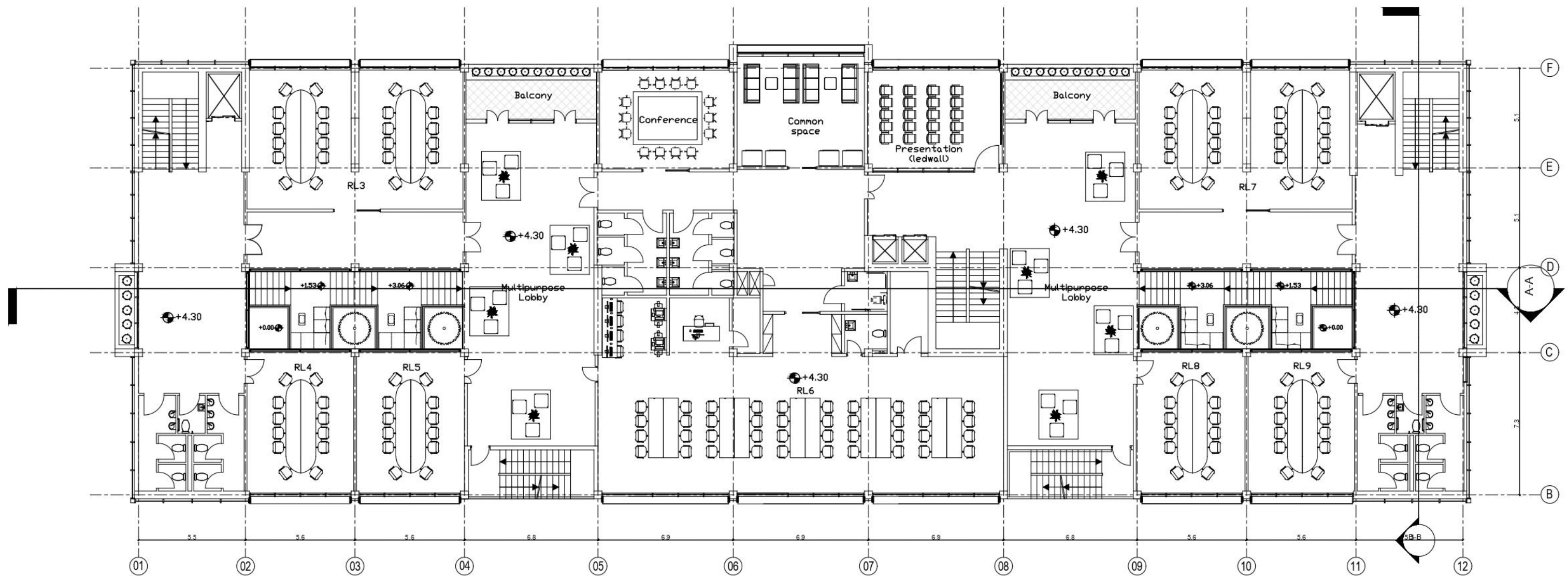

**Politecnico  
di Torino**

Master's Degree in Building Engineering  
 Candidate: Saadoun Alhellani  
 Thesis Supervisor: Prof Marika Mangosio

Regenerative design of  
 Politecnico's Revolution House

First Floor Plan

Scale 1:200

A03

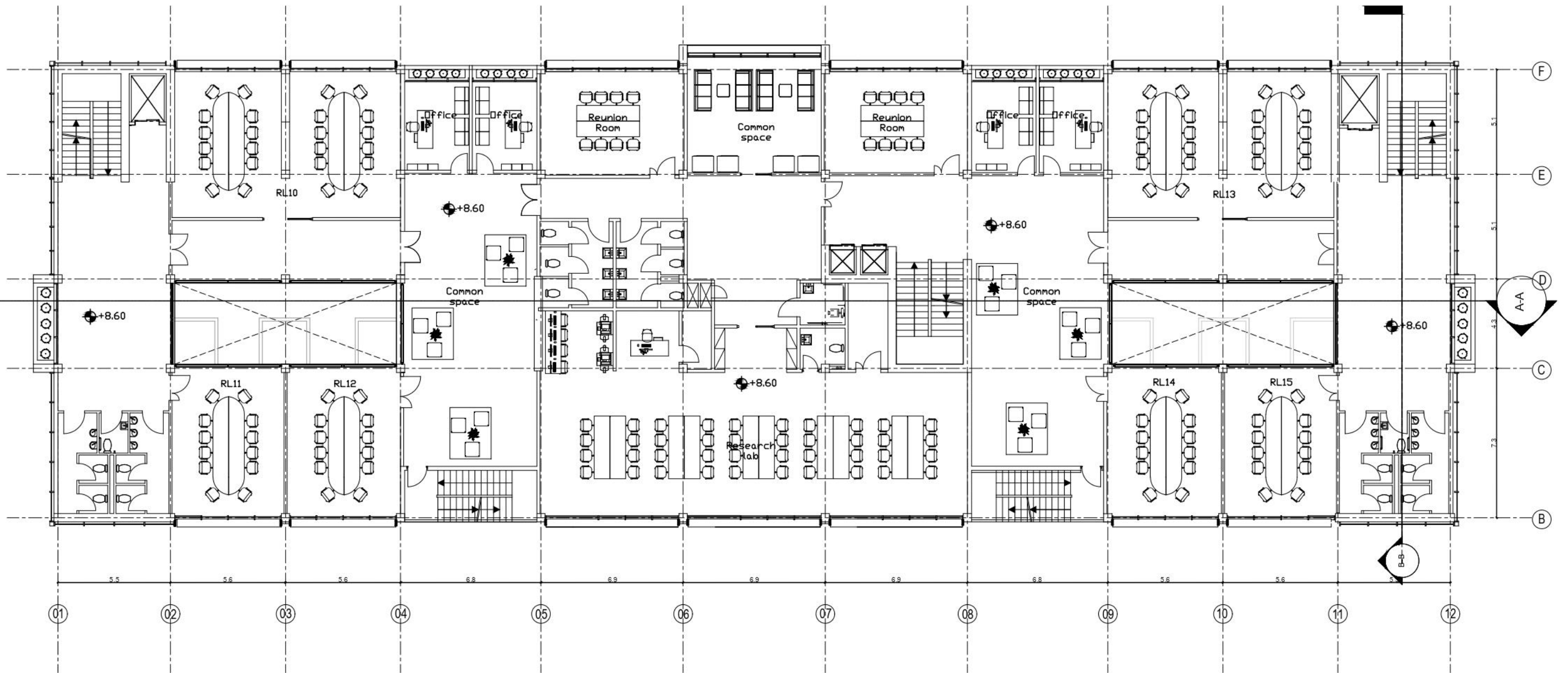

**Politecnico  
di Torino**

Master's Degree in Building Engineering  
 Candidate: Saadoun Alhellani  
 Thesis Supervisor: Prof Marika Mangosio

Regenerative design of  
 Politecnico's Revolution House

Second Floor Plan

Scale 1:200

A04

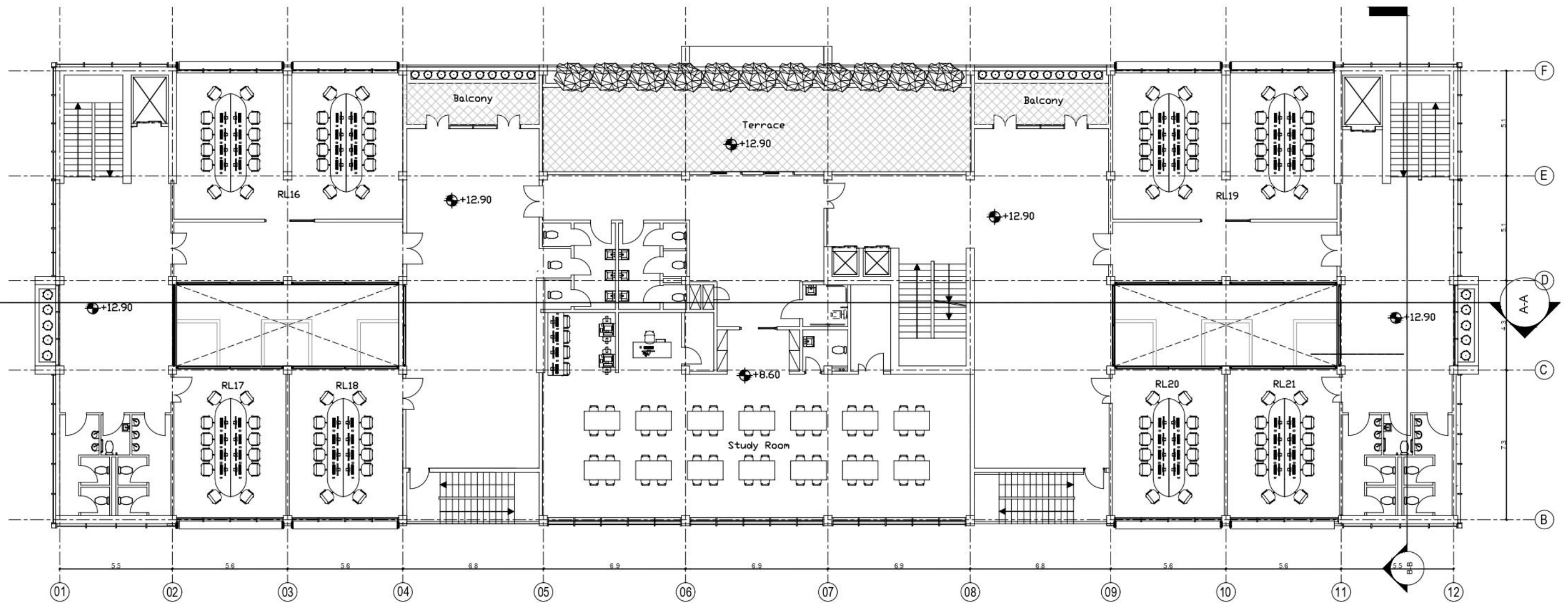

**Politecnico  
di Torino**

Master's Degree in Building Engineering  
 Candidate: Saadoun Alhellani  
 Thesis Supervisor: Prof Marika Mangosio

Regenerative design of  
 Politecnico's Revolution House

Third Floor Plan

Scale 1:200

A05



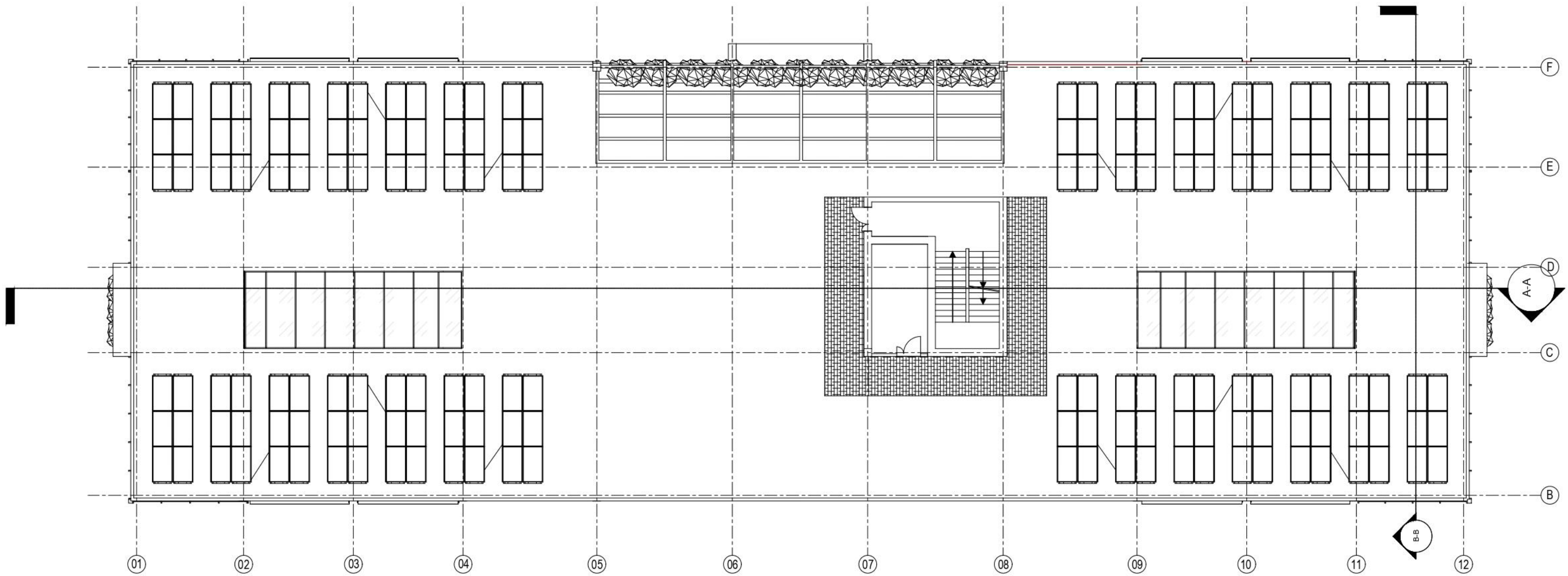

**Politecnico  
di Torino**

Master's Degree in Building Engineering

Candidate: Saadoun Alhellani

Thesis Supervisor: Prof Marika Mangosio

Regenerative design of  
Politecnico's Revolution House

Roof Plan

Scale 1:200

A06

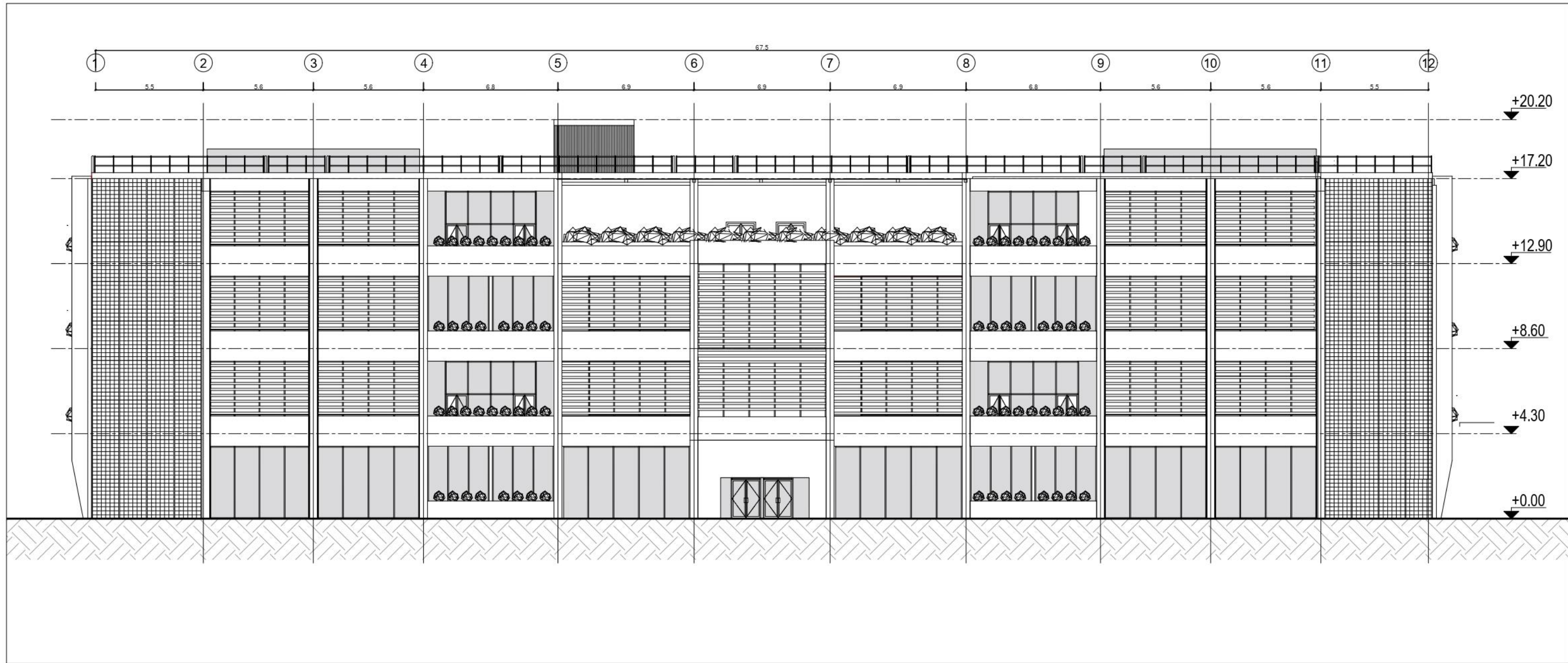

**Politecnico  
di Torino**

Master's Degree in Building Engineering

Candidate: Saadoun Alhellani

Thesis Supervisor: Prof Marika Mangosio

Regenerative design of  
Politecnico's Revolution House

North West Elevation

Scale 1:200

A07

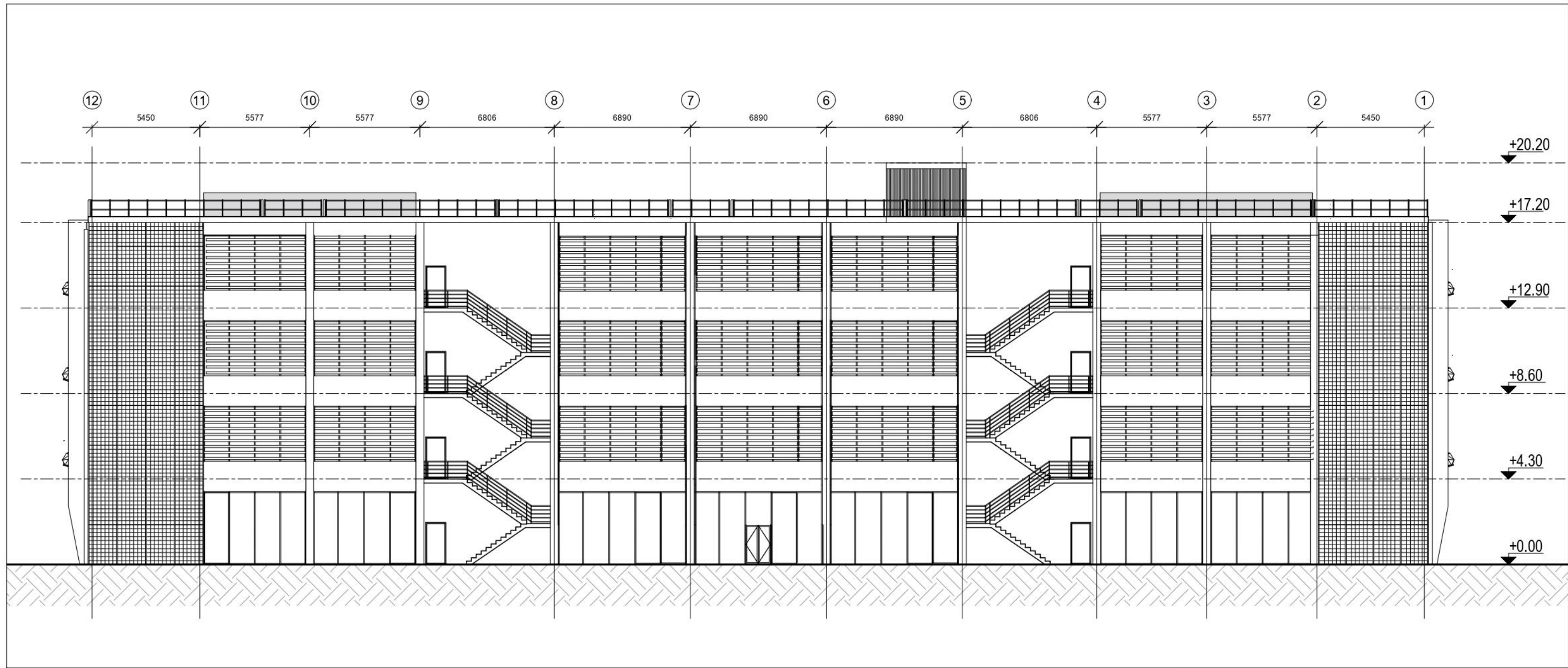

**Politecnico  
di Torino**

Master's Degree in Building Engineering  
 Candidate: Saadoun Alhellani  
 Thesis Supervisor: Prof Marika Mangosio

Regenerative design of  
 Politecnico's Revolution House

South East Elevation

Scale 1:200

A08

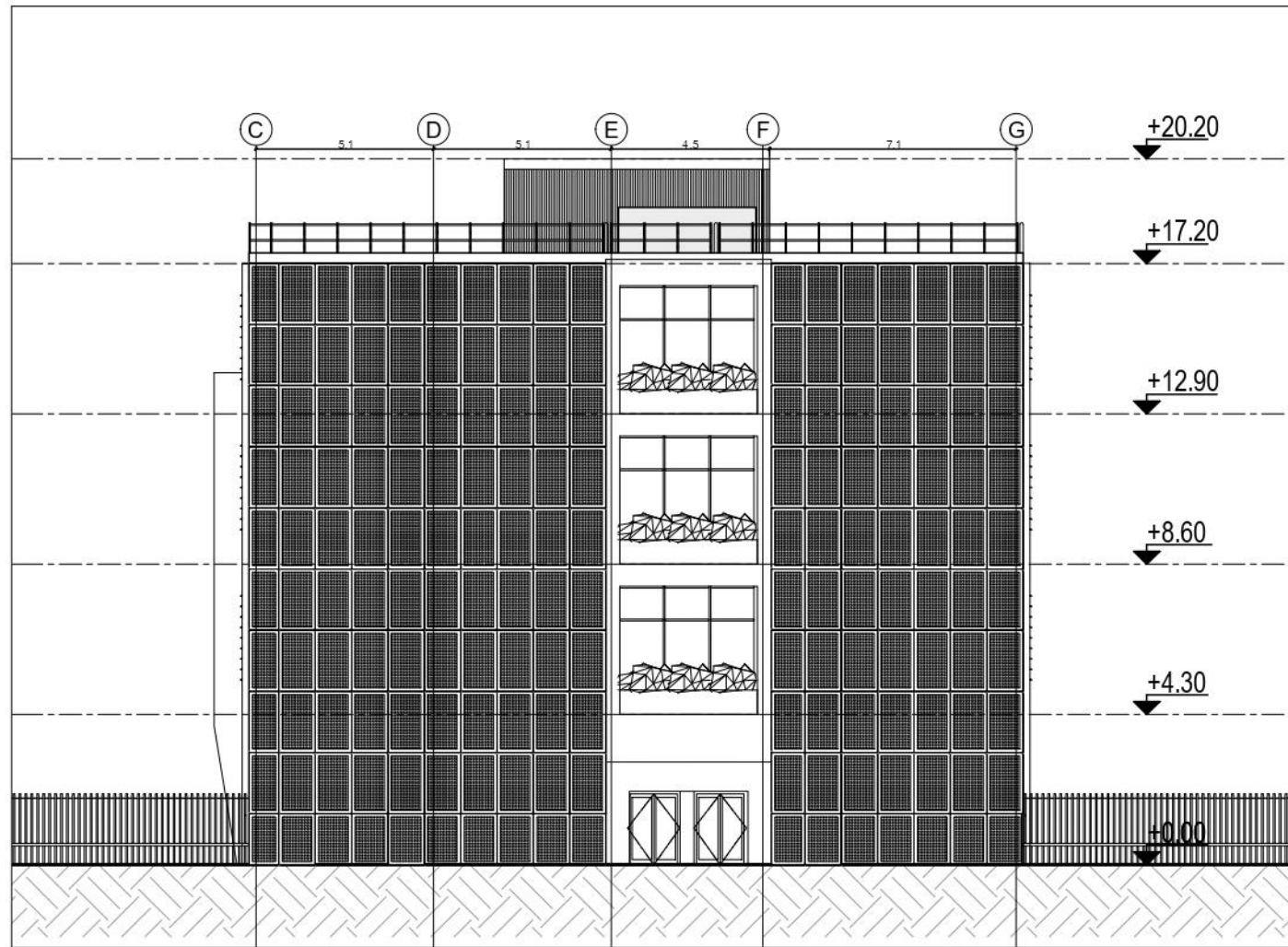

Southwest Elevation

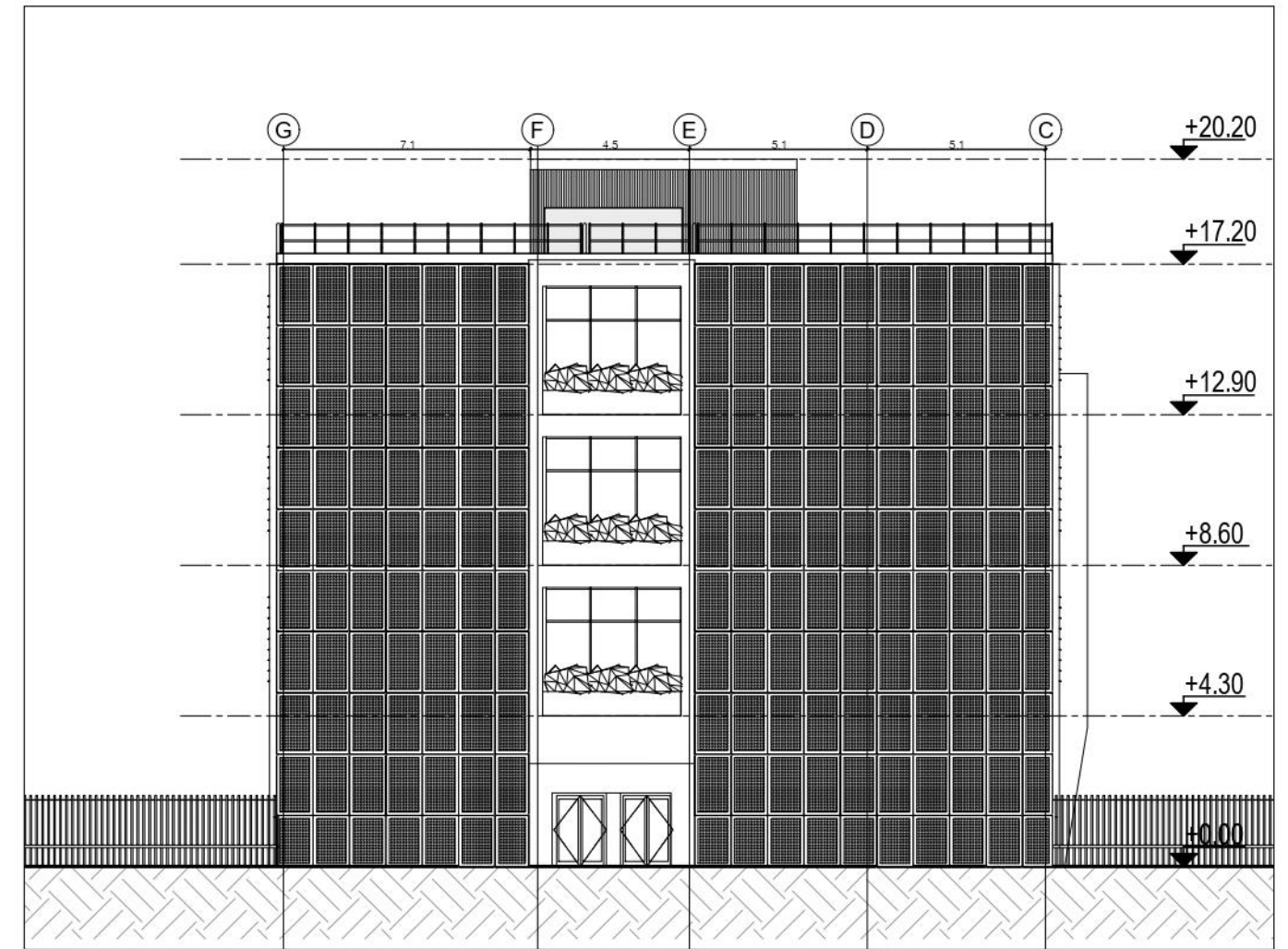

Northeast Elevation



**Politecnico  
di Torino**

Master's Degree in Building Engineering  
Candidate: Saadoun Alhellani  
Thesis Supervisor: Prof Marika Mangosio

Regenerative design of  
Politecnico's Revolution House

Southwest / Northeast Elevations

Scale 1:200

A09

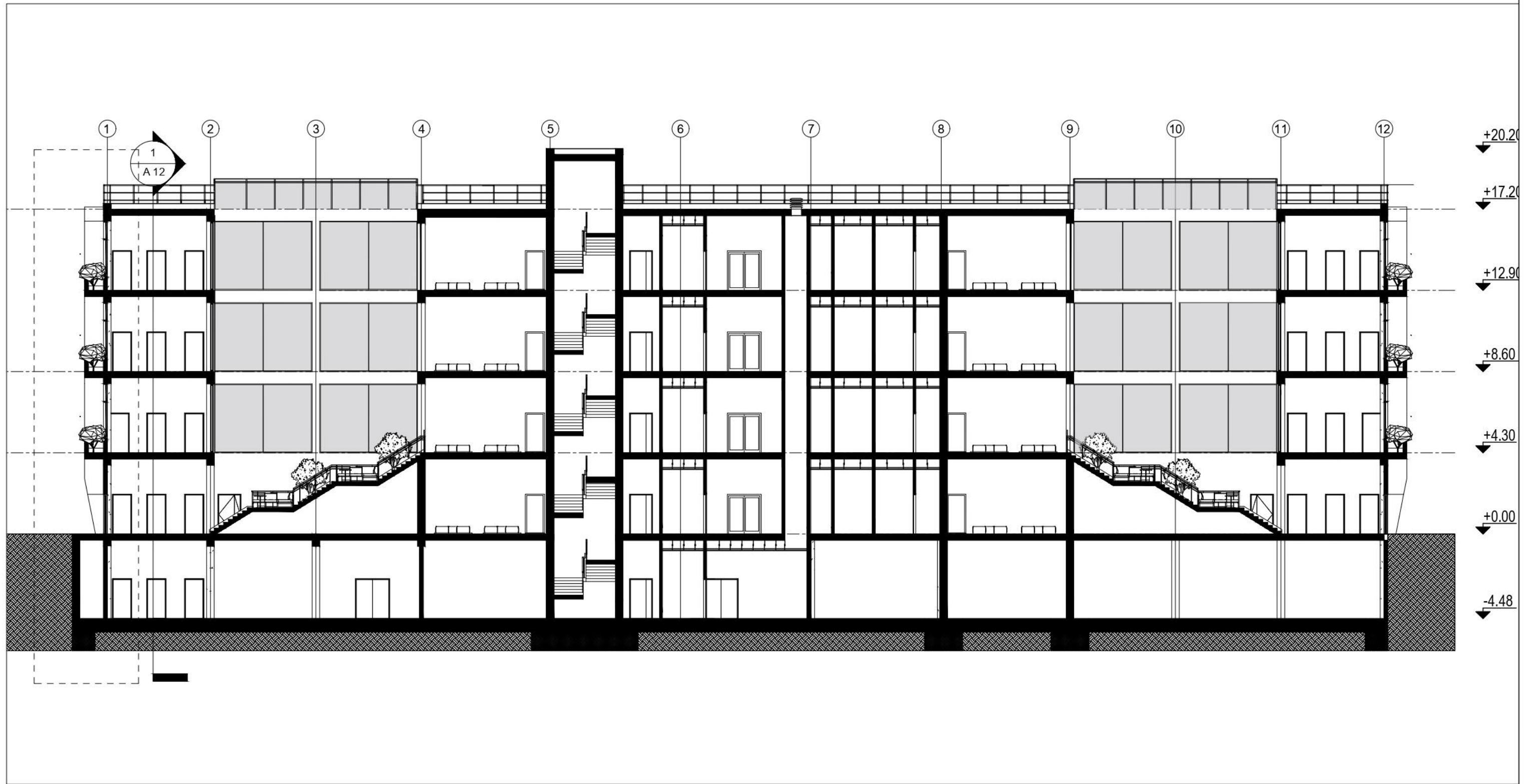

**Politecnico  
di Torino**

Master's Degree in Building Engineering  
 Candidate: Saadoun Alhellani  
 Thesis Supervisor: Prof Marika Mangosio

Regenerative design of  
 Politecnico's Revolution House

Section A-A

Scale 1:200

A10

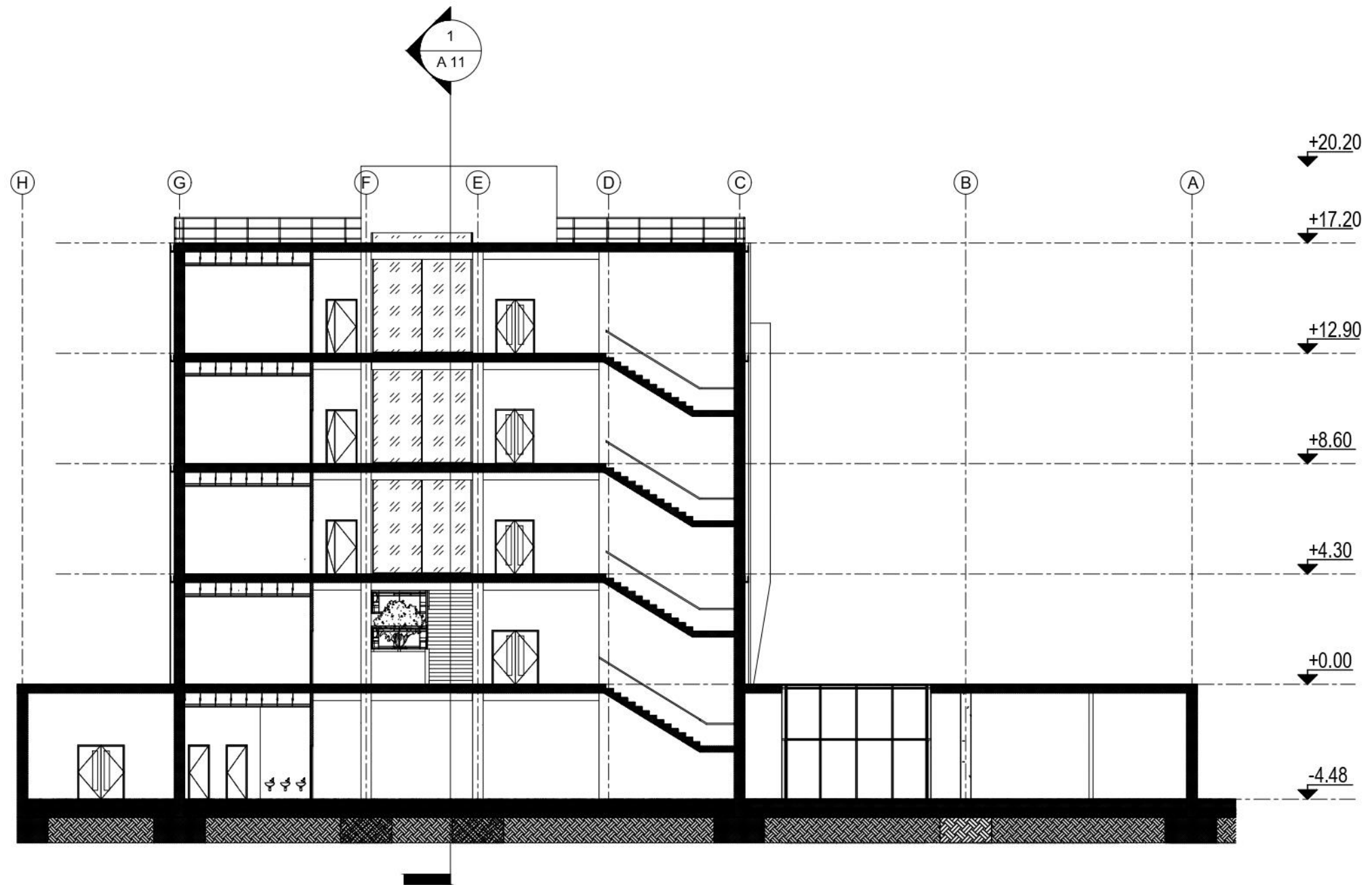

**Politecnico  
di Torino**

Master's Degree in Building Engineering  
 Candidate: Saadoun Alhellani  
 Thesis Supervisor: Prof Marika Mangosio

Regenerative design of  
 Politecnico's Revolution House

Section B-B

Scale 1:200

A11

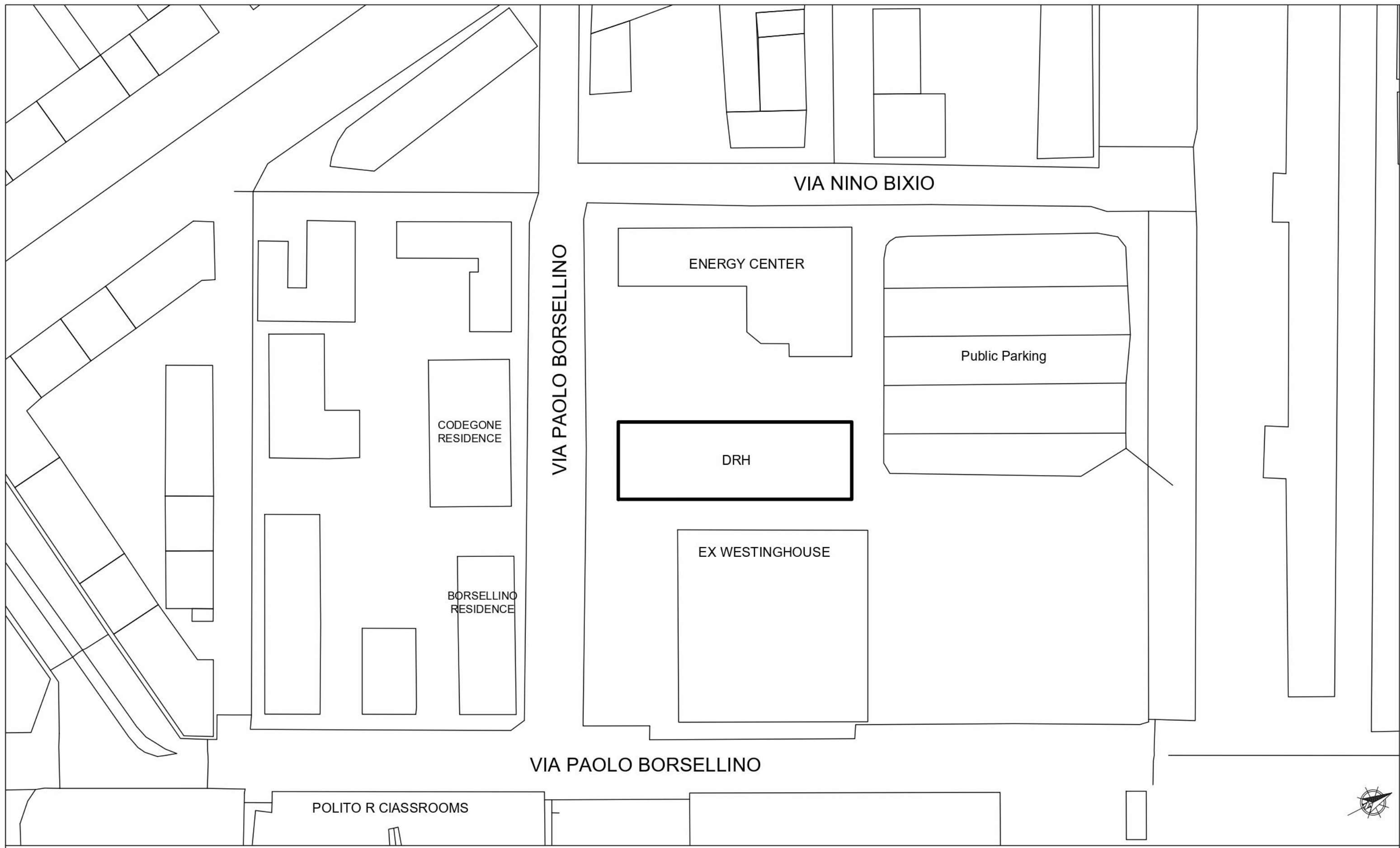

**Politecnico  
di Torino**

Master's Degree in Building Engineering  
 Candidate: Saadoun Alhellani  
 Thesis Supervisor: Prof Marika Mangosio

Regenerative design of  
 Politecnico's Revolution House

Site Plan with context	
Scale 1:1000	A14

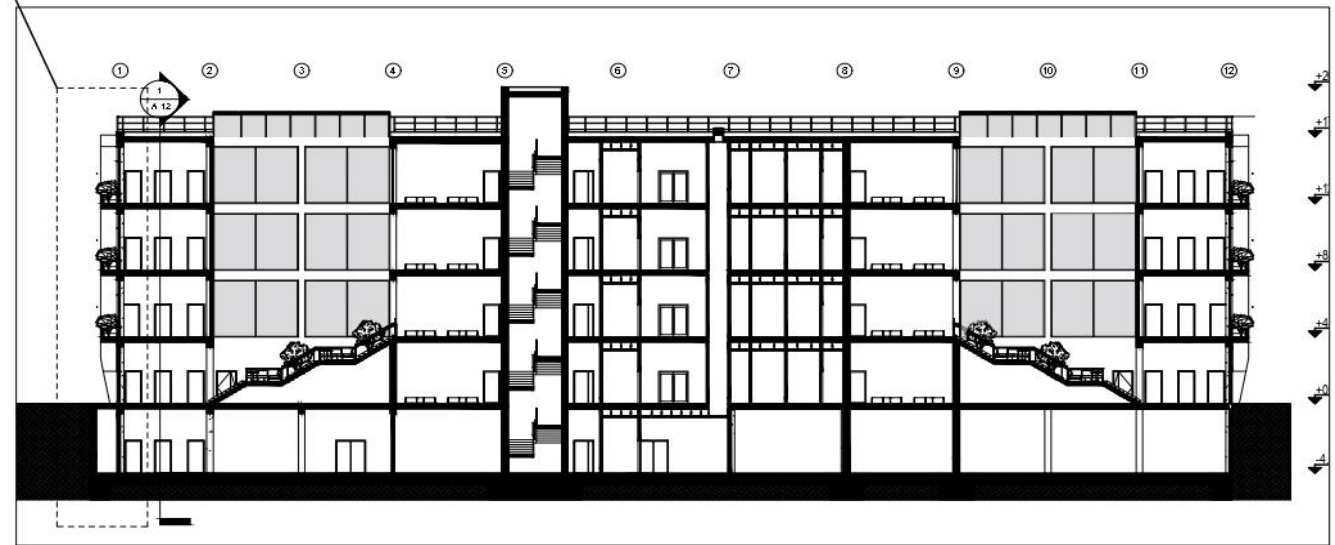
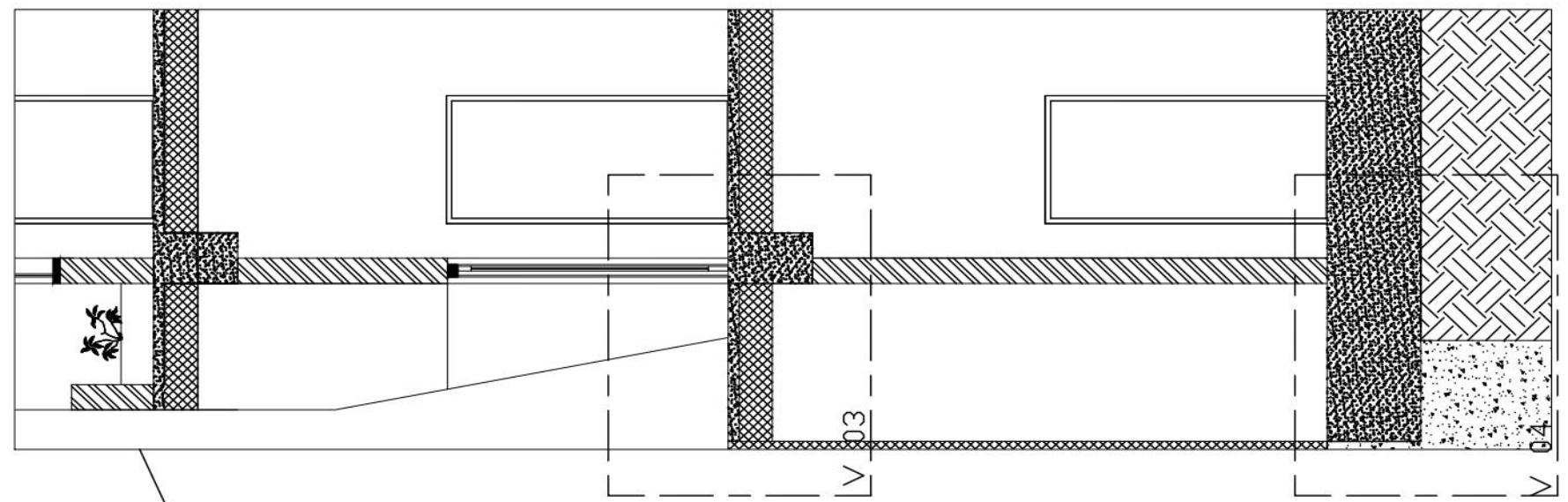
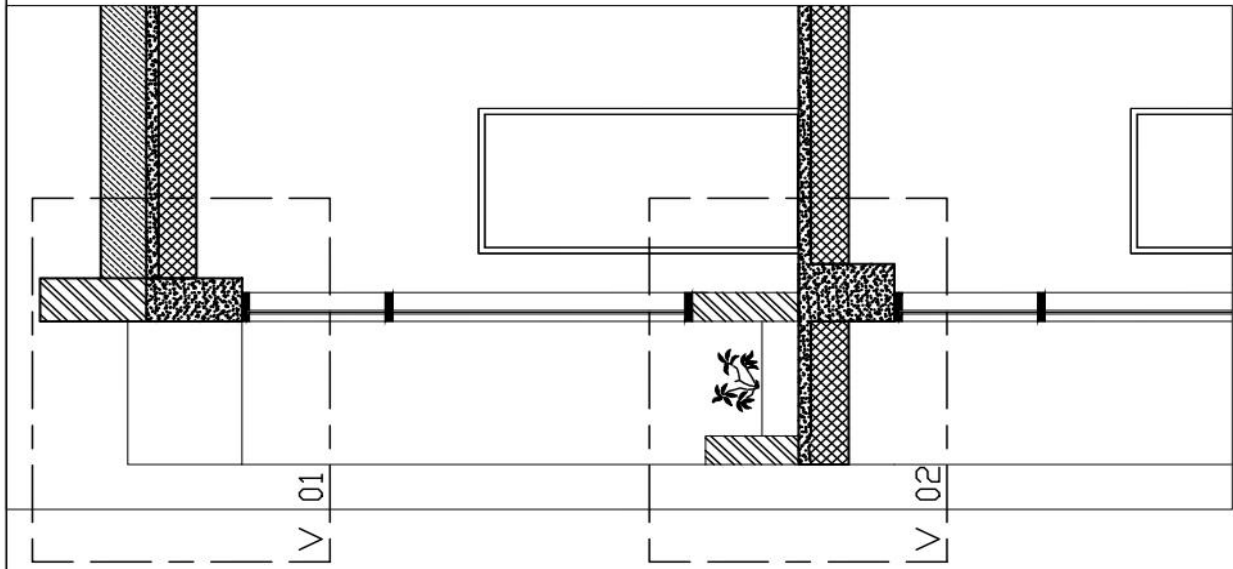

**Politecnico  
di Torino**

Master's Degree in  
Building Engineering  
Candidate: Saadoun Alhellani  
Thesis Supervisor: Marika Mangosio

Regenerative design of  
Politecnico's Revolution House

Vertical Nodes

Scale 1:50

A15



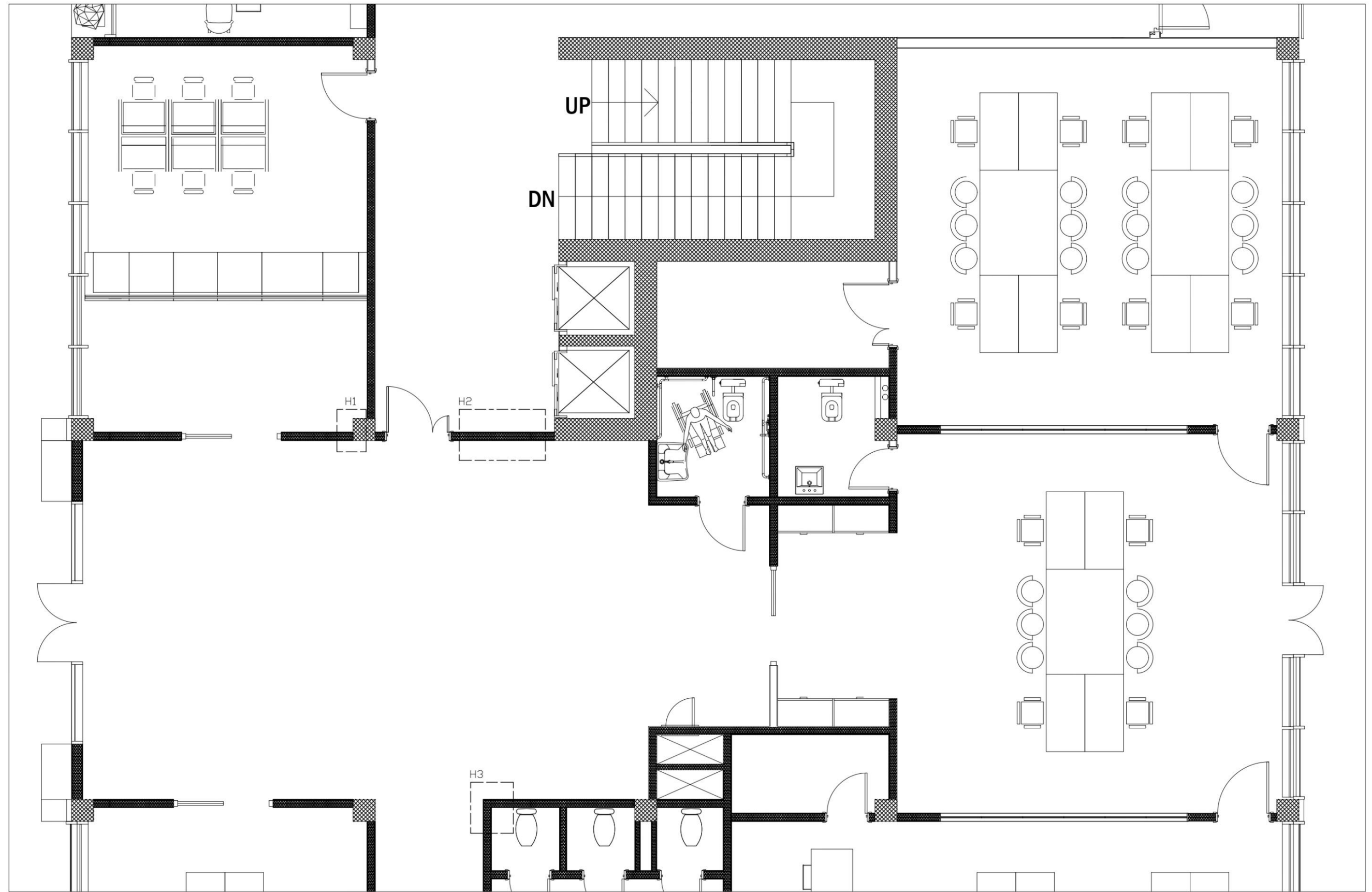

**Politecnico  
di Torino**

Master's Degree in Building Engineering  
Candidate: Saadoun Alhellani  
Thesis Supervisor: Prof Marika Mangosio

Regenerative design of  
Politecnico's Revolution House

Ground floor plan (A@ papersize)

Scale 1:50

A16

## Connections and Technical details :

### Legend:

- 1: Coping Cover
- 2- Bitumen Vapour Barrier
- 3-Thermal Insulation
- 4-Screw DIN571
- 5-Paver or stone ballast
- 6-Extensive Substrate
- 7- Filling layer
- 8- Thermal Insulation
- 9-Geotextile Protection Layer
- 10- Insulation

V01 scale 1:10

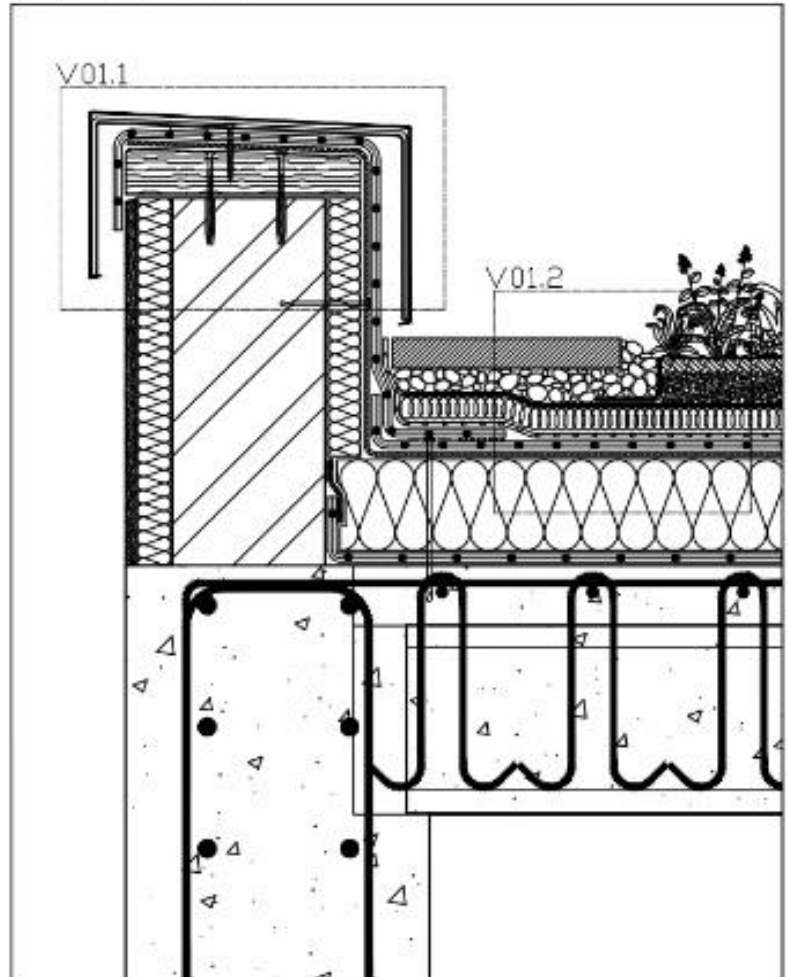

V01.1 scale 1:5

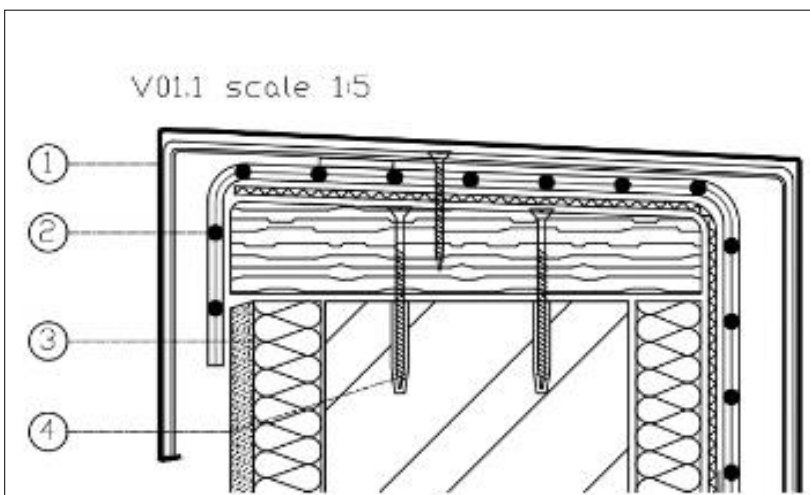

V01.2 scale 1:5

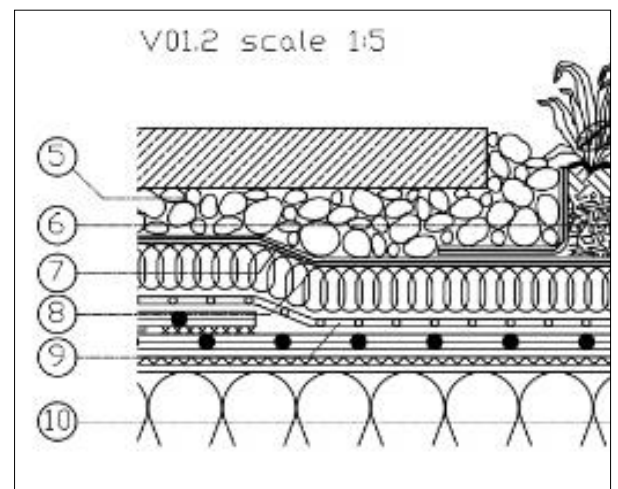

A02 Scale 1:10

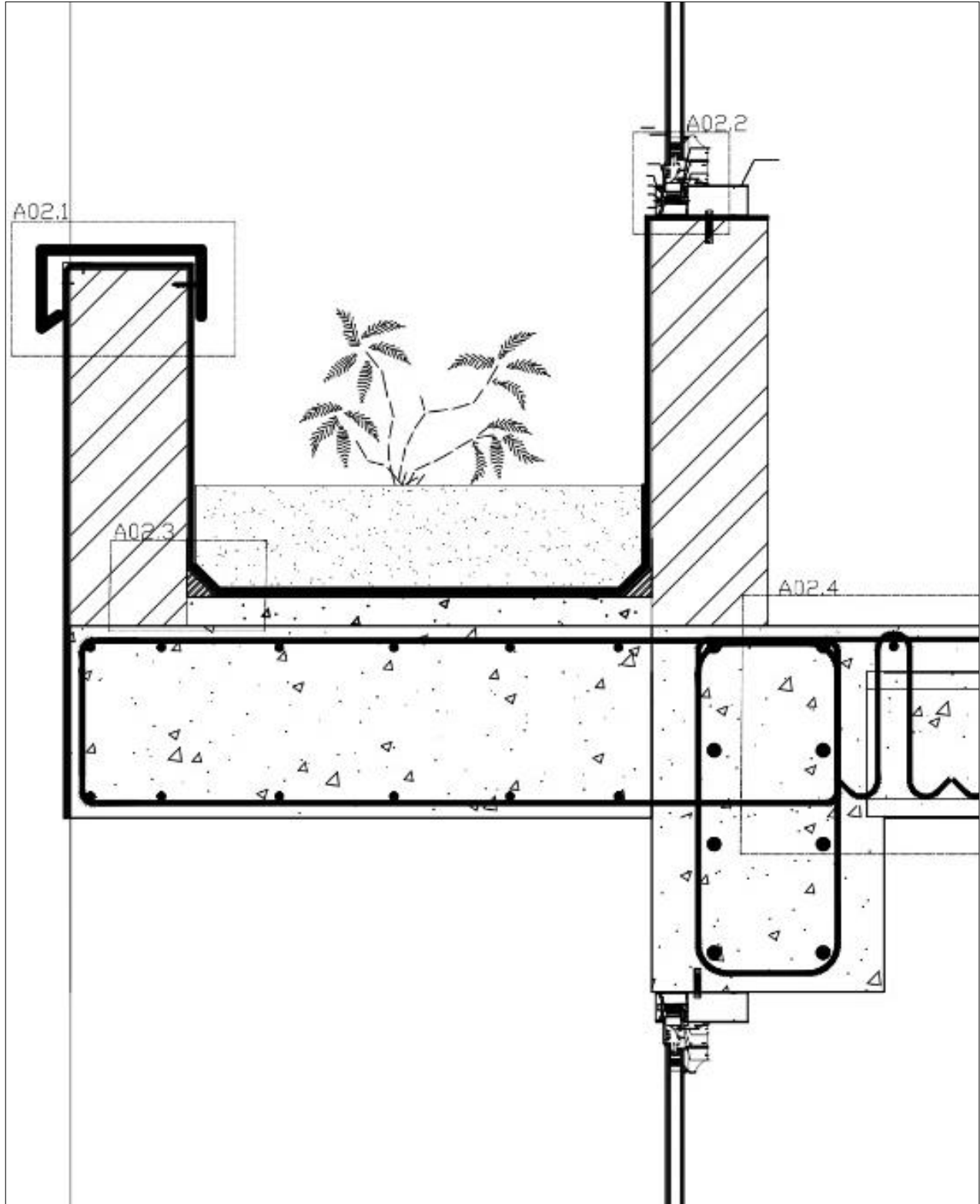

Legend:

- 1- Coping metal cover
- 2- Continuous cleat
- 3- Bitumen vapour barrier
- 4- PE protection Layer
- 5- Roofing nails
- 6- Screw with rubber washer
- 7- EPDM-gasket
- 8- Metal covering
- 9- Presser
- 10- Fixing screw
- 11- Glass-fiber thermal covering
- 12- Linear distancer
- 13- EPDM-gasket
- 14- Metal covering
- 15- Bitumen vapour barrier
- 16- PE protection layer
- 17- Sand substrate
- 18- Sloping plate
- 19- Insitu concrete tapping 8cm
- 20- Wire mesh in concrete tapping
- 21- Typical styrrup
- 22- Hollow core slab

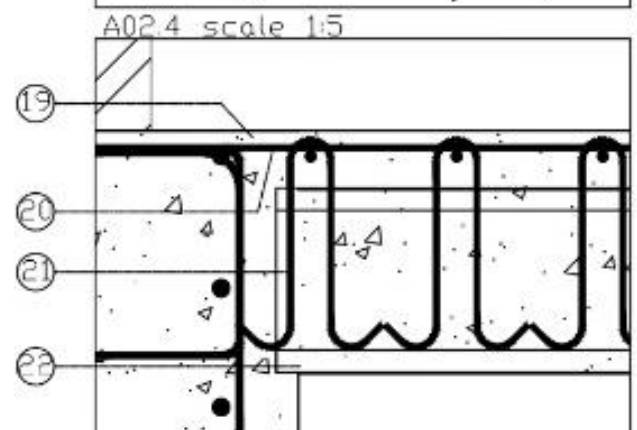
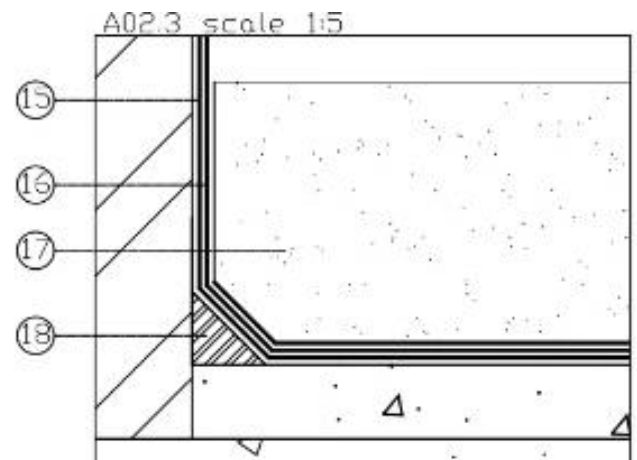
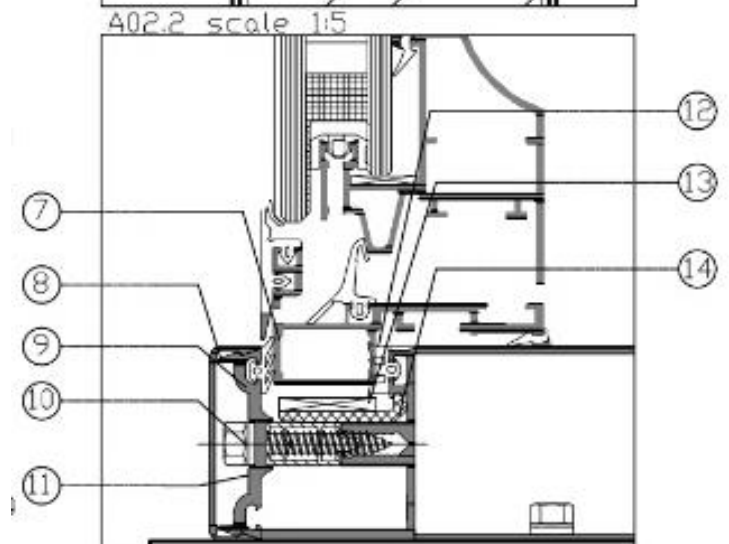
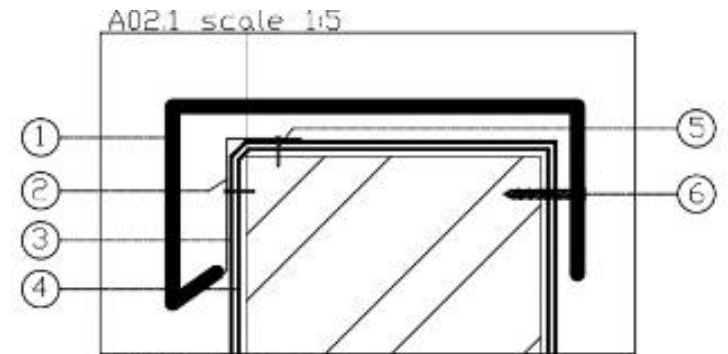

V04 Scale 1:10

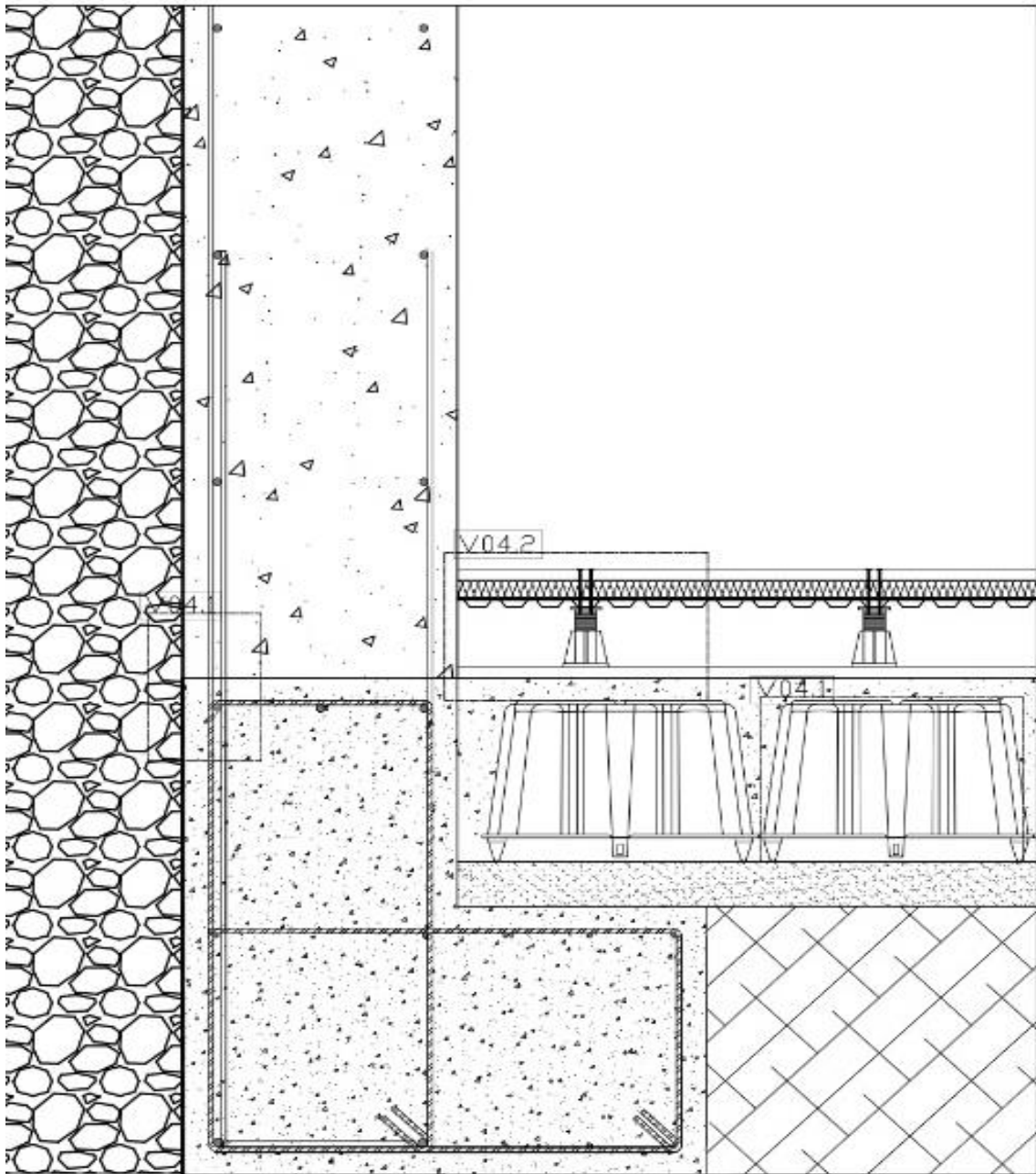

## Legend

- 1- Shear wall reinforcment
- 2- Horiz. Bars corner reinforcment
- 3- External insulation
- 4- Insitu concrete covering
- 5- Plastic cupolex
- 6- Fixing screw
- 7- Thermal Insulation
- 8- Metal cover
- 9- Floating floor

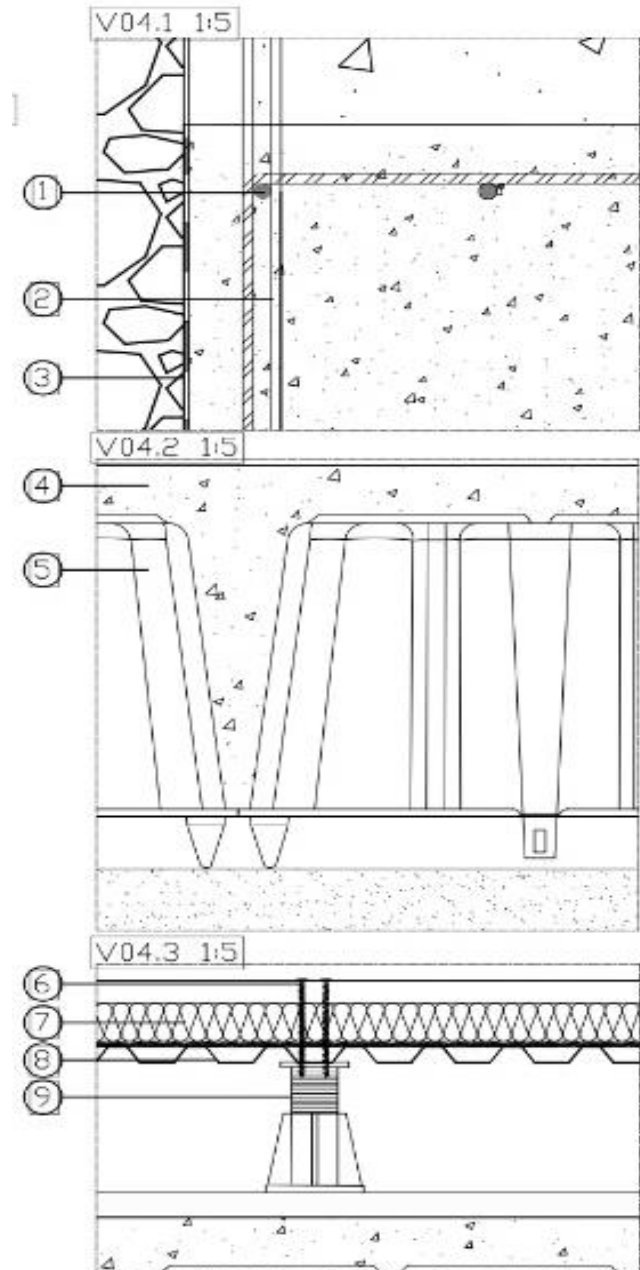

Legend :

- 1- Treated sil I plate
- 2- Continuous sealent
- 3- SIP rim board
- 4- 8d nails
- 5- Anchor bolt
- 6- 8d nails
- 7- Continous sealant
- 8- Bloack spline
- 9- 8d nails
- 10- Sip screw into edge blocking
- 11- Continuous sealant
- 12- Dry wall

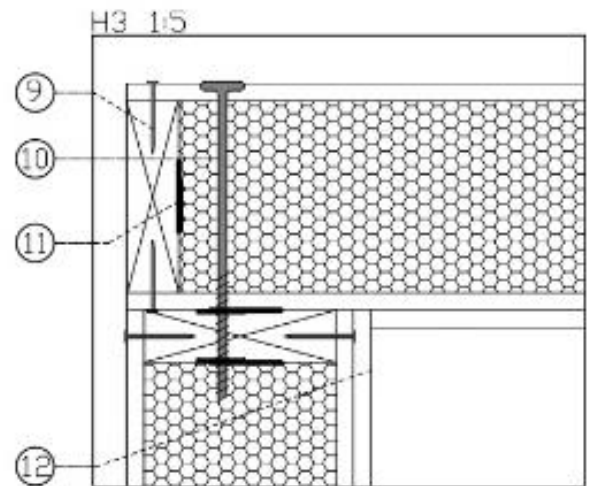
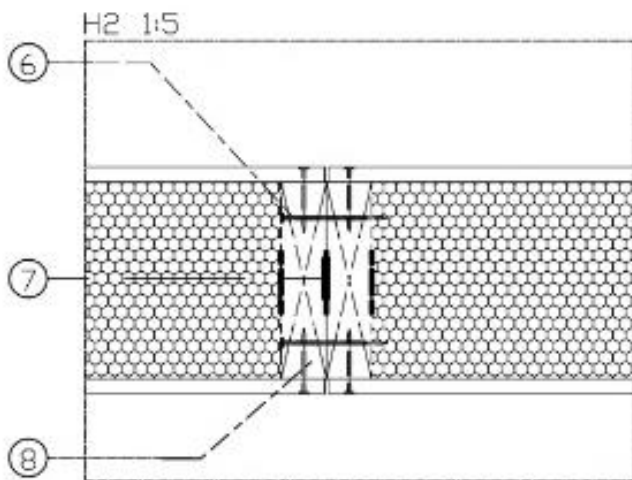
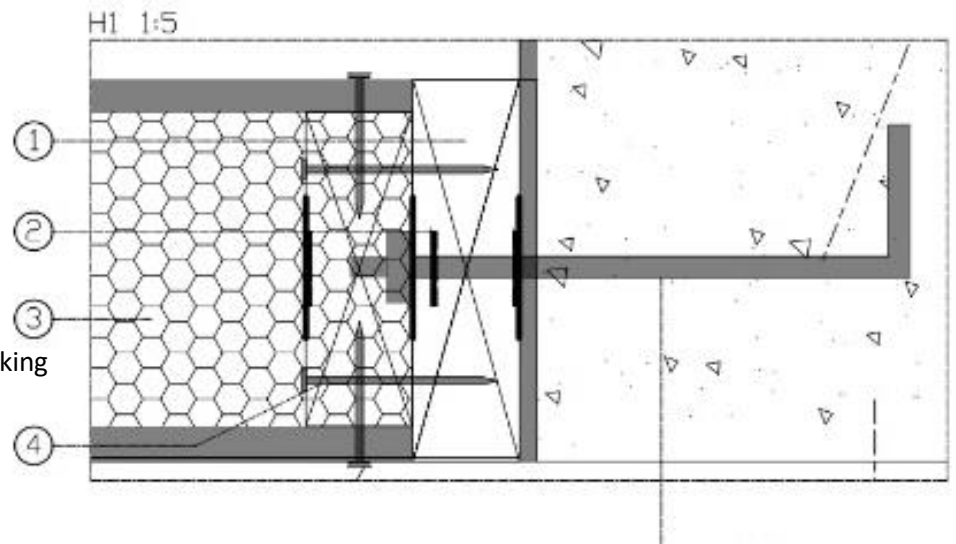

## 7. Sustainable Materials and Construction

For congruence reasons, a sustainable vision of the construction process demands that the constructive system aligns with sustainability principles. When considering SIPs walls as a constructive system, especially within the framework of "**dry construction**," it becomes clear that these panels can meet the following sustainable requirements:

**Ecologic:** SIPs are known for their energy efficiency, which can result in lower environmental impact through reduced energy consumption in the finished building. This aligns well with the ecologic requirement of sustainability. Moreover, dry construction systems, like SIPs, generate less on-site waste and require fewer resources during installation, further reducing their environmental footprint.

**Easily Installable:** SIPs are pre-fabricated and easily installed, which is a hallmark of dry construction. This not only leads to shorter construction times but also minimizes on-site disruptions, meeting the easily installable criterion for sustainable construction.

**Flexible:** SIPs are adaptable to various architectural designs, and this flexibility is enhanced when employing dry construction techniques. The pre-engineered nature of SIPs and the precision in their fabrication make them well-suited to accommodate a wide range of aesthetic and functional requirements.

**Reusable:** While SIPs are not typically disassembled and reused, they can be recycled, and the materials can be repurposed for other applications, promoting sustainability in a similar fashion to dry construction systems that allow for the reusability of components.

**Dismountable:** SIPs can be disassembled in a controlled manner for renovations or repairs, which is a sustainable practice compared to conventional construction methods that may involve more destructive teardown. Dry construction methods, in general, are more amenable to disassembly and modification.

**Recyclable:** The materials used in SIPs, such as OSB and foam insulation, can often be recycled at the end of their life cycle, reducing waste and conserving resources. Similarly, many dry construction components are designed with recyclability in mind, aligning with the recyclable criterion.

SIPs represent a sustainable construction solution that embodies these principles, especially when incorporated into dry construction practices. The combination of SIPs' energy efficiency and the efficiency of dry construction reduces environmental impact and minimizes resource consumption. The ease of installation and adaptability to various architectural styles makes SIPs a practical choice



for environmentally conscious construction projects. Additionally, the recyclability and potential for disassembly ensure that the materials used in SIPs walls can contribute to a more sustainable construction industry, particularly when embraced within a dry construction framework.

The sustainability of the "Digital Revolution House" (DRH) extends to the very core of its construction, integrating environmentally responsible materials and practices. This section delves into the selection and use of sustainable materials for vertical partitions and facades, highlighting the project's commitment to reducing its environmental footprint.

### Vertical Partitions

In this project SIPs walls are used for external and internal vertical partitions. SIPs represent a pivotal choice in the "Digital Revolution House" (DRH), underscoring the project's commitment to sustainability and innovation in construction. SIPs are prefabricated building components known for their exceptional thermal insulation, strength, and efficiency. The decision to use SIPs for the project's vertical partitions offers numerous advantages, both in terms of environmental responsibility and construction benefits.

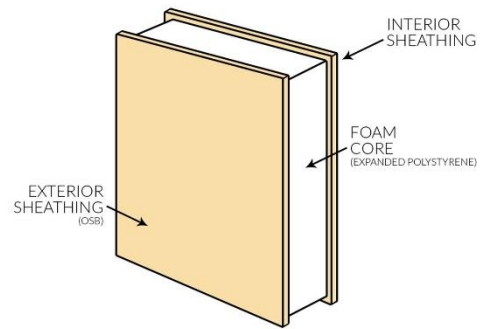

Figure 23- Single Sips panel

### Eco-Friendly Construction

SIPs are engineered wood-based panels comprising an insulating foam core sandwiched between two structural facings. This unique composition results in a highly efficient insulation material. The use of SIPs directly aligns with the project's sustainability goals, as they contribute to significant energy savings over the building's lifecycle.

The high thermal resistance of SIPs reduces heat transfer, ensuring that the DRH remains comfortable in varying weather conditions. This results in reduced energy consumption, as less energy is needed for heating and cooling. By mitigating heat loss during cold periods and minimizing heat gain during hot seasons, SIPs play a crucial role in decreasing the building's carbon footprint.

### Sustainable Manufacturing

One of the key environmental advantages of SIPs is their sustainable manufacturing process. The panels are fabricated in a controlled factory environment, which significantly reduces on-site waste and material usage. This prefabrication results in minimal construction waste and a more efficient use of resources. SIPs are custom-designed for the specific needs of the project, ensuring minimal material wastage.

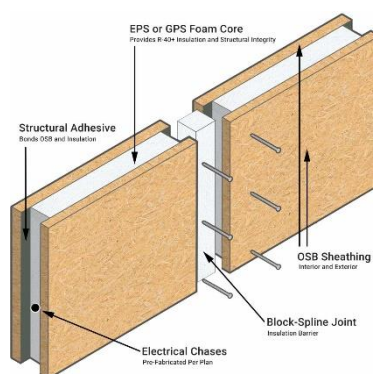

Figure 24- 2 Sips panels connection



Figure 25- installing Sips panels

## Energy Efficiency

The high thermal performance of SIPs goes beyond eco-friendliness; it has a direct impact on energy efficiency. The superior insulation properties help maintain a consistent indoor temperature, reducing the need for mechanical heating and cooling systems. This, in turn, leads to lower energy consumption, resulting in reduced operational costs and a smaller carbon footprint.

In the following table the thermal transmittance of the external walls (20 cm) and internal one (15 cm) is calculated :

Type of component							
External wall							
Layers (int-ext)	d [cm]	$\rho$ [kg/m <sup>3</sup> ]	$\mu$ [-]	c [J/kg°C]	$\lambda$ [W/m <sup>2</sup> °C]	R [m <sup>2</sup> °C/W]	opt $\lambda \rightarrow R$
Internal surface							0.13
I OSB	1.5	600	74	2100	0.120		<input type="checkbox"/>
II Foam	17.0	30	192	1250	0.036		<input type="checkbox"/>
III OSB	1.5	600	74	2100	0.120		<input type="checkbox"/>
IV							<input type="checkbox"/>

Tab. 9 input data for calculation

LEGEND
d = thickness
$\rho$ = density
$\mu$ = water vapour resistance factor
c = specific heat capacity
$\lambda$ = thermal conductivity
R = thermal resistance

Tab. 10 - Legend

Type of component							
Vertical internal partition							
Layers (int-ext)	d [cm]	$\rho$ [kg/m <sup>3</sup> ]	$\mu$ [-]	c [J/kg°C]	$\lambda$ [W/m <sup>2</sup> °C]	R [m <sup>2</sup> °C/W]	opt $\lambda \rightarrow R$
Internal surface							0.13
I OSB	1.5	600	74	2100	0.120		<input type="checkbox"/>
II Foam	12.0	30	192	1250	0.036		<input type="checkbox"/>
III OSB	1.5	600	74	2100	0.120		<input type="checkbox"/>

Tab. 9 – input data for calculation

Parameter	Module	Time shift
Internal thermal admittance ( $Y_i$ )	1.425 W/(m <sup>2</sup> K)	4.48 h
External thermal admittance ( $Y_{ee}$ )	1.491 W/(m <sup>2</sup> K)	4.96 h
Periodic thermal transmittance ( $Y_{ie}$ )	<b>0.180 W/(m<sup>2</sup>K)</b>	-3.08 h
Internal areal heat capacity ( $\kappa_i$ )	<b>20.7 kJ/(m<sup>2</sup>K)</b>	
External areal heat capacity ( $\kappa_e$ )	21.9 kJ/(m <sup>2</sup> K)	
Thermal resistance (R)	5.142 (m <sup>2</sup> K)/W	
Thermal transmittance (U)	<b>0.194 W/(m<sup>2</sup>K)</b>	
Decrement factor (f)	<b>0.926</b>	
Thickness (s)	<b>20.0 cm</b>	
Areal mass (m)	<b>23 kg/m<sup>2</sup></b>	
Time lag ( $\phi$ )	<b>3.08 h</b>	

Tab. 11 – thermal properties of sips walls 20 cm

Parameter	Module	Time shift
Internal thermal admittance ( $Y_i$ )	1.388 W/(m <sup>2</sup> K)	4.35 h
External thermal admittance ( $Y_{ee}$ )	1.388 W/(m <sup>2</sup> K)	4.35 h
Periodic thermal transmittance ( $Y_{ie}$ )	<b>0.242 W/(m<sup>2</sup>K)</b>	-2.77 h
Internal areal heat capacity ( $\kappa_i$ )	<b>20.3 kJ/(m<sup>2</sup>K)</b>	
External areal heat capacity ( $\kappa_e$ )	20.3 kJ/(m <sup>2</sup> K)	
Thermal resistance (R)	3.843 (m <sup>2</sup> K)/W	
Thermal transmittance (U)	<b>0.260 W/(m<sup>2</sup>K)</b>	
Decrement factor (f)	<b>0.931</b>	
Thickness (s)	<b>15.0 cm</b>	
Areal mass (m)	<b>22 kg/m<sup>2</sup></b>	
Time lag ( $\phi$ )	<b>2.77 h</b>	

Tab. 12 – thermal properties of sips walls 15 cm

	Thermal Transmittance	Areal Mass	Internal Areal Heat Capacity	External Areal Heat Capacity
<b>External Walls 20 cm</b>	0.194 W/m <sup>2</sup> K	23 Kg/m <sup>2</sup>	20.7 KJ/M <sup>2</sup> K	21.9 KJ/M <sup>2</sup> K
<b>Internal walls 15 cm</b>	0.26 W/m <sup>2</sup> K	22 Kg/m <sup>2</sup>	20.3 KJ/M <sup>2</sup> K	20.3 KJ/M <sup>2</sup> K

Tab. 10 – Thermal properties comparison

## Quick and Efficient Construction

Beyond their environmental benefits, SIPs also streamline the construction process. They are lightweight, which makes handling and transportation more efficient. SIPs can be installed quickly, accelerating construction timelines and reducing labor costs.

The precise, factory-made nature of SIPs ensures that they fit together seamlessly, minimizing the potential for air leaks or thermal bridges. This tight envelope results in a building that is not only energy-efficient but also comfortable and free from drafts.

In summary, the choice to use SIPs for vertical partitions in the DRH is a testament to the project's commitment to sustainable construction practices. The eco-friendly nature of SIPs, their energy efficiency, and the streamlined construction process make them an ideal choice for a project that seeks to push the boundaries of sustainable design and innovation.

### Precast Prestressed Concrete for Columns and Slabs

The "Digital Revolution House" (DRH) integrates precast prestressed concrete as a fundamental building material for its columns and slabs. This deliberate choice aligns with the project's core principles of structural integrity, sustainability, and innovative construction practices. Precast prestressed concrete offers a multitude of advantages, making it an exceptional choice for vertical load-bearing elements.



Figure 26- Precast hollow core concrete slab

### Strength and Durability

Precast prestressed concrete is renowned for its exceptional strength and durability. By using precast elements for the columns and slabs of the DRH, the project ensures that the structure can withstand both the test of time and environmental stressors. The inherent durability of concrete reduces the long-term maintenance requirements, further contributing to sustainability.

### Optimized Use of Materials

The prestressing technique applied to the concrete components enhances their efficiency. Precast prestressed concrete elements are designed with a focus on optimizing the use of concrete materials. This means that less material is required to achieve the same structural strength, resulting in reduced resource consumption and environmental impact. The design philosophy mirrors the sustainable ethos of the DRH by minimizing material waste.

### Reduced On-Site Work and Waste

One of the key advantages of using precast concrete components is the significant reduction of on-site work. The elements are manufactured in a controlled factory environment, ensuring precision and quality. This prefabrication results in minimized on-site construction waste and the potential for mistakes, making the construction process more efficient.

The reduced on-site work also leads to decreased disturbance of the immediate surroundings and local ecosystems, which is in line with sustainable construction practices.



*Figure 27- Installation of Precast hollow core*

#### *Energy Efficiency*

The thermal mass properties of concrete contribute to the energy efficiency of the building. Precast prestressed concrete's ability to absorb and store heat results in temperature stabilization. As a consequence, the DRH exhibits reduced temperature fluctuations, requiring less energy for heating and cooling.

Incorporating precast prestressed concrete columns and slabs into the DRH design bolsters the project's structural reliability, offering a high degree of resistance to environmental factors and ensuring longevity. Furthermore, the methodical use of materials and energy-efficient attributes underscore the DRH's commitment to sustainability, making it a beacon of innovation in the realm of structural design and construction.

**Horizontal Aluminum Sun Louvers:** The incorporation of horizontal aluminum sun louvers in the DRH's facades serves a dual purpose. These shading devices enhance energy efficiency by reducing solar heat gain, thereby decreasing the need for artificial cooling. Simultaneously, they offer an aesthetic dimension to the building's exterior, showcasing the fusion of function and form.

**Aluminum Screen Walls for Facade:** Aluminum screen walls contribute to the DRH's facade design, promoting natural ventilation while also acting as an additional layer of shading. These screen walls optimize airflow and daylight, lessening the reliance on mechanical systems and artificial lighting, further reducing energy consumption.

**Curtain Walls:** Curtain walls in the DRH reflect a commitment to transparency and natural light. They allow an abundance of daylight into the interior spaces, lessening the need for artificial lighting during the day. These curtain walls are designed with a focus on energy efficiency, insulation, and sustainability.

The inclusion of these sustainable materials and construction methods aligns the DRH with principles of eco-conscious design and responsible resource use. These choices result in reduced energy demands, waste reduction, and overall environmental efficiency, marking a significant stride toward a more sustainable future.

For the curtain wall, it was adopted a double-glazed unit filled with argon and with integrated shading devices, in order to guarantee thermal and visual comfort in summer. The curtain wall is a unitized façade, so composed by precast modulus, already with their own frame, to be only assembled on site. All these choices are justified by site management and energetic considerations. Some of the moduli are openable, in order to respect the minimum R.A.I. criteria. Moreover, the curtain wall was integrated with some monocrystalline silica solar cells, in order to use the façade as a prosumer, collecting solar energy usable for the building operation.

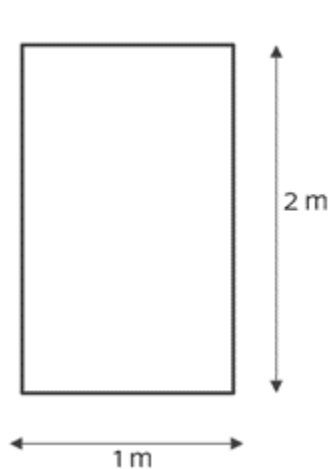

Figure 14 -modulus size

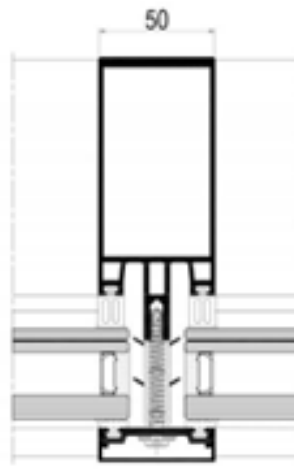

Figure 15- frame

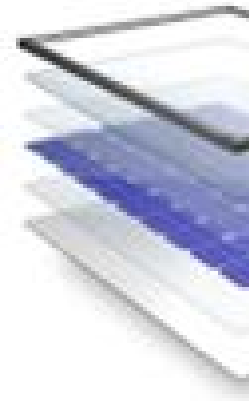

Figure 16-integrated solar cells

### Windows/doors:

For external windows and doors, it was used a triple glazing unit, without the use of integrated shading devices, in order to guarantee a good insulation in winter. This solution was not suitable for the curtain wall, due to the huge dimensions for energetic considerations, since a too high transmittance would have caused discomfort in summer. The doors are completed by a vasistas opening above, in order to increase the height of them, guarantee a higher amount of light entering the building. The windows are sliding one, so to avoid problems of encumbrance inside.

## Conclusion :

The evolution of the Digital Revolution House (DRH) stands as a testament to the dynamic nature of architectural innovation and the symbiotic relationship between sustainability and visionary design.

The proposed thesis introduces a compelling new vision for the DRH, one that capitalizes on the building's inherent potential while reimagining its internal spatial dynamics. This design revision maintains the structure's essential rectangular form, showcasing how thoughtful modifications in space allocation can enhance functionality without compromising the building's fundamental integrity.

By advocating for ground floor spaces tailored to fostering collaboration, education, and interaction, and upper floors dedicated to research, exhibitions, and innovative centers like the Smart Mobility Center, the new proposal envisions a harmonious blend of academia, industry, and technological advancement within the DRH's walls.

Moreover, this proposal underscores the essential role of architectural adaptability in responding to evolving needs and aligning with the ethos of sustainability. By emphasizing the integration of environmentally conscious practices, the DRH's new design reinforces the notion that architecture can be a driving force in cultivating a more interconnected, sustainable, and innovative future.

The significance of the DRH extends beyond its physical presence; it embodies a commitment to interdisciplinary collaboration, societal advancement, and the holistic integration of academia and industry. Positioned strategically within the Politecnico di Torino campus, it symbolizes a beacon of progressive education and technological innovation, fostering a culture where diverse disciplines converge to address real-world challenges.

In conclusion, the proposed new design for the DRH not only embodies a sophisticated architectural vision but also serves as a testament to the potential of sustainable design principles in shaping the future of academia, technology, and societal progress. It stands poised to elevate the role of architecture in catalyzing positive change, inspiring future generations to embrace innovation, sustainability, and collaborative endeavors.